

Material Engineering in Regenerative Cardiac Surgery: "Yesterday and Today"

Roman Major

r.major@imim.pl

Marcin Surmiak, Marek Sanak, Maciej
Gawlikowski, Roman Kustosz,
Lukasz Major, Hanna Plutecka,
Przemysław Kurtyka, Juergen M.
Lackner, Boguslaw Major



1882 Roland Ross- „The Vivisector Vivisected”

AN ARTIFICIAL HEART REVIVES A CORPSE:
 SIR RONALD ROSS'S UNPUBLISHED STORY OF 1882,
 "THE VIVISECTOR VIVISECTED"

A.J.J. CARMICHAEL

Introduction

In 1882, exactly 100 years before the first artificial heart was im-
 planted in a human chest [1], Ronald Ross—then an obscure young
 medical man serving in India—wrote “The Vivisector Vivisected,” a
 hair-raising short story in which a man who bled to death is revived by an
 artificial heart.

When Ross (1857–1932) wrote “Vivisector” he was still some 15 years
 away from the famous researches in which he incriminated certain mos-
 quitoes as the transmitters of malaria, a discovery that brought him the
 Nobel Prize. In 1882, however, he had only just qualified in medicine
 (studied at his father’s behest but for which he felt “no predilection at
 all”) [2, p. 29] and had left England to join the Indian Medical Service.
 Ross had for years been a serious writer and enjoyed many other intel-
 lectual interests, but now he found himself in South India among col-
 leagues who “seemed to take interest in absolutely nothing. . . .” [2, p.
 54]. Since his medical duties were negligible, the 25-year-old Ross de-
 voted his considerable leisure to mathematics and the classics, and to
 writing poems, plays, and novels [2, pp. 48–51].

During a brief assignment away from his base he wrote (in his words)
 “a weird short story called ‘The Vivisector Vivisected.’” [2, p. 19]. Ross’s
 biographer, Megroz, found the story “as gruesome as the title suggests.

The research was supported in part by a Research Career Award from the National
 Institutes of Health. The author thanks also Dr. Roger Abraham and the Royal College
 of Physicians and Surgeons of Glasgow for permission to study and to publish Ronald
 Ross’s “Vivisector.” He also expresses indebtedness to two early colleagues Clifford Berger,
 Gustave J. Darricau, and Richard J. Wolfe for helpful comments.
 *Department of Tropical Public Health, Harvard School of Public Health, 665 Huntington
 Avenue, Boston, Massachusetts 02115.

© 1988 by The University of Chicago. All rights reserved.
 0361-3682/88/3105-0578\$11.00

Annals of the New York Academy of Sciences, 513, 3–Spring 1988 | 541

1982 Utah- implantation

1928 Henry Hallet Dale & Edgar Schuster restoring total circulation of the heartless animal

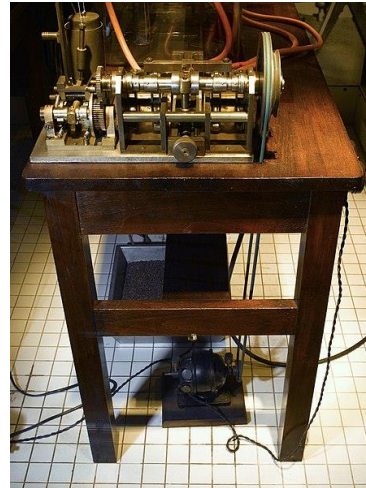

1937 Władimir Demichow



1935 Charles Lindbergh perfusion pump („The Walking Dead”)



American Society for Artificial International Organs- ASAIO – Peter Salisbury

1957 Willem Kolff & Robert Jarvik

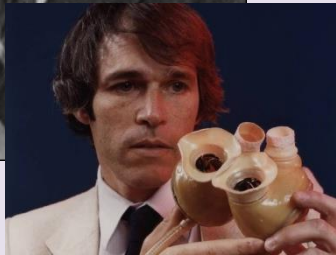

1963 Paul Winchell

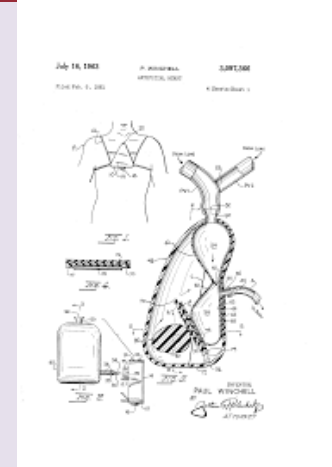
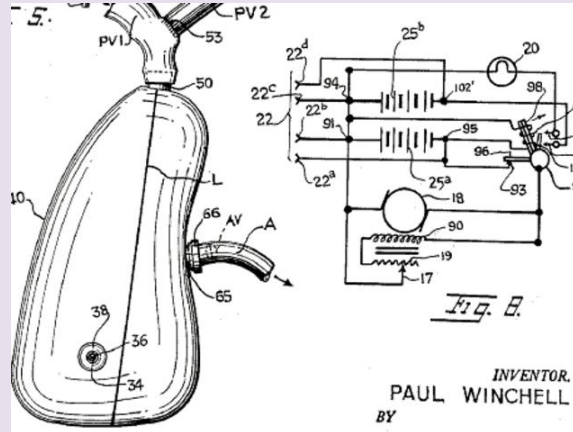

Michael E. DeBakey & Liotta left ventricular bypass pump



Dr. Michael E. DeBakey, left, Dr. Denton A. Cooley and the early artificial heart device that led to their long-running split.

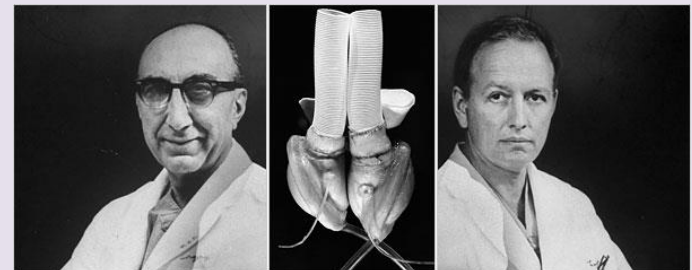

1991- Powstanie Fundacji Rozwoju Kardiochirurgii





„Moje wielkie pragnienie stworzenia polskiego sztucznego serca nareszcie w pełni się urzeczywistnia. Usilne starania o otoczenie tego przedsięwzięcia opieką państwa, uwieńczone uchwaleniem Wieloletniego Programu "Polskie Sztuczne Serce", uważam za ogromny sukces. Bardzo się z tego cieszę i życzę powodzenia wszystkim, którzy zaangażowani są w realizację prac”.

https://www.youtube.com/watch?v=71_E3Hh2Jqg

prof. Zbigniew Religa

„My great desire to create a Polish Artificial Heart finally fully fulfills...”

prof. Zbigniew Religa

„POLISH ARTIFICIAL HEART” Medicine

Modern technology



https://www.youtube.com/watch?v=7QFhxfVF7SA&list=PLMkpKh2ylbEa90ThOL0F6vQC_aKmHvgs8

DIVISION BY TYPE OF FAILURE

- Acute failure
- Long-term failure
- Patients with cardiomyopathy

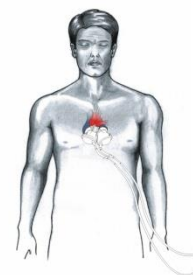
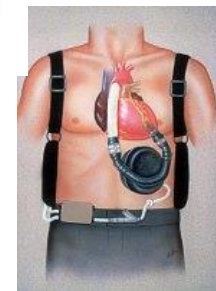
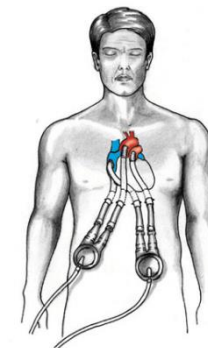

DIVISION BY SUPPORT TIME

Short-term

- An acute heart failure with a good prognosis of regeneration
- An infirmity with an uncertain prognosis for further treatment

Permanent support

- chronic heart failure disqualifying for transplantation
- cardiomyopathy

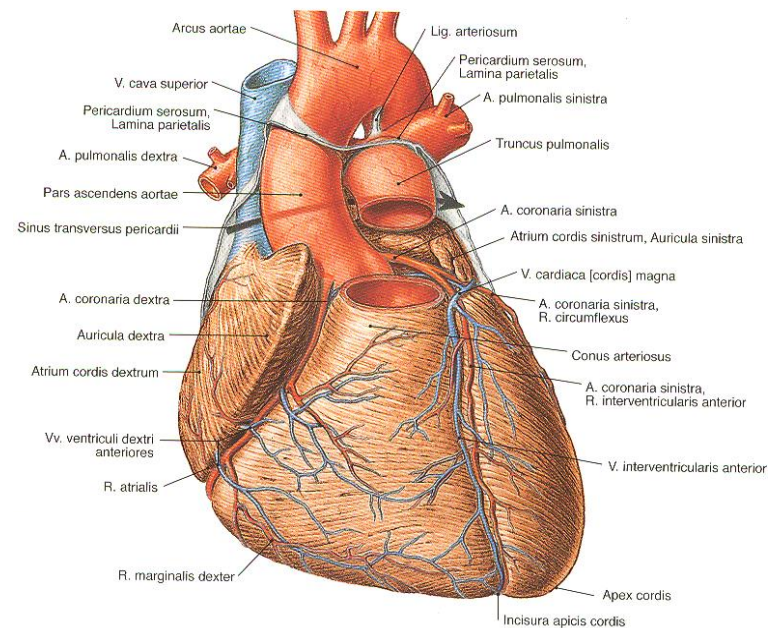

More than 40 teams from 35 scientific and research institutions, clinical centers and professional entities producing elements of heart prostheses participated in the implementation of the Program.

As part of 5 projects, 17 research tasks and 12 implementation tasks, covering over 200 stages, were implemented.

I STRATEGIC GOAL

Developed families of Polish heart prostheses, with a completely implantable permanent heart prosthesis as a final element

II STRATEGIC GOAL

Clinical development of the use of Polish heart prostheses in the treatment of patients with critical heart failure

III STRATEGIC GOAL

Creation of a highly specialized scientific and technological platform for the purpose of conducting comprehensive research and development in the field of heart prostheses

Effects of the program



IMIM PAN- leader of the task
Prof. B. Major

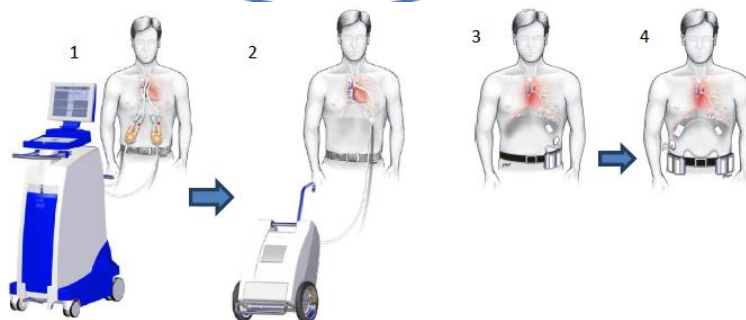
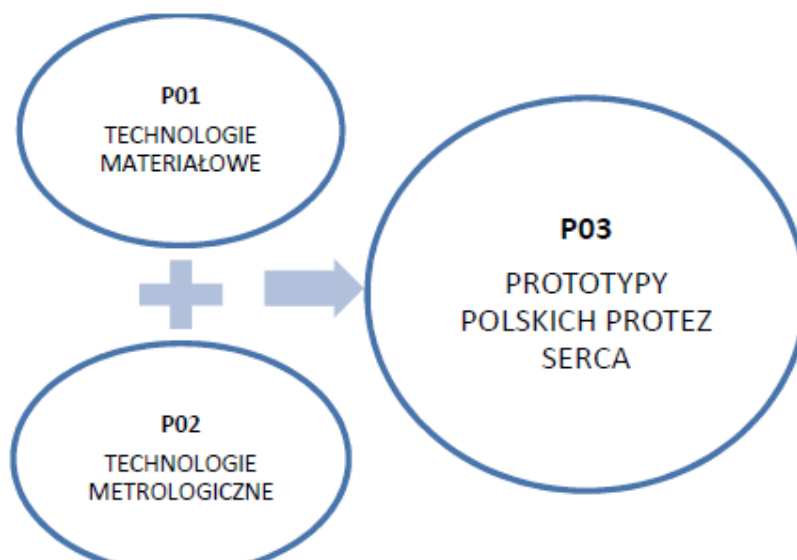

System POLVAD

PROSTHESIS

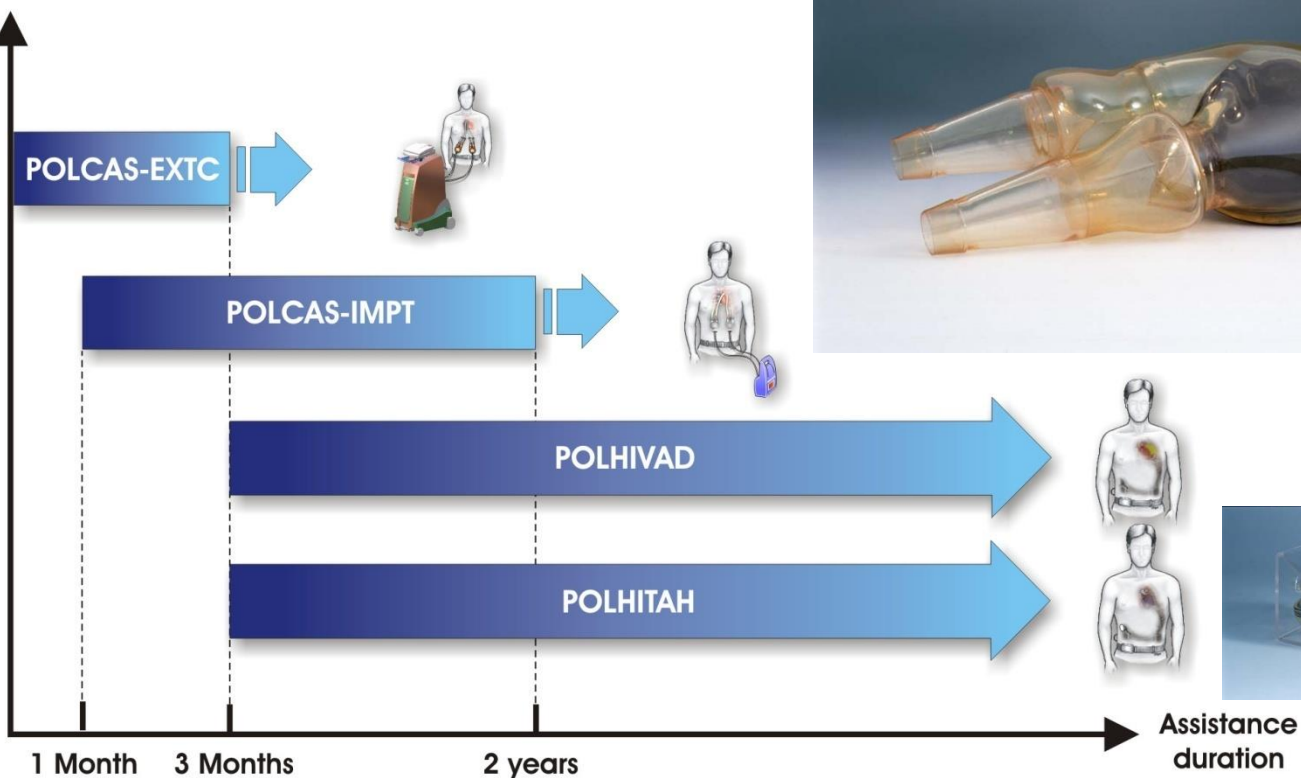

Membrane

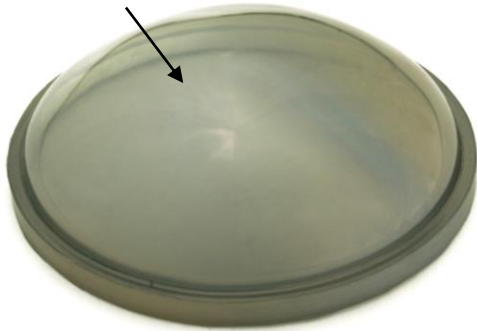

Chamber

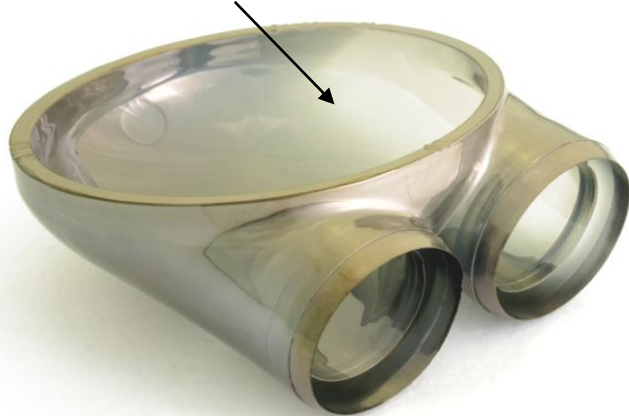

The goal of the work is the reduction of life-threatening thrombo-emboli formation in heart assist systems by a new material design

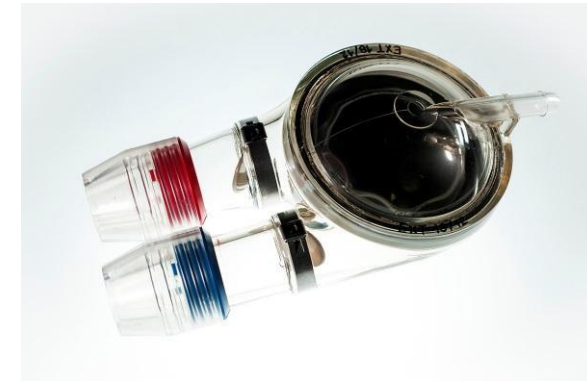

Valve



Heart support

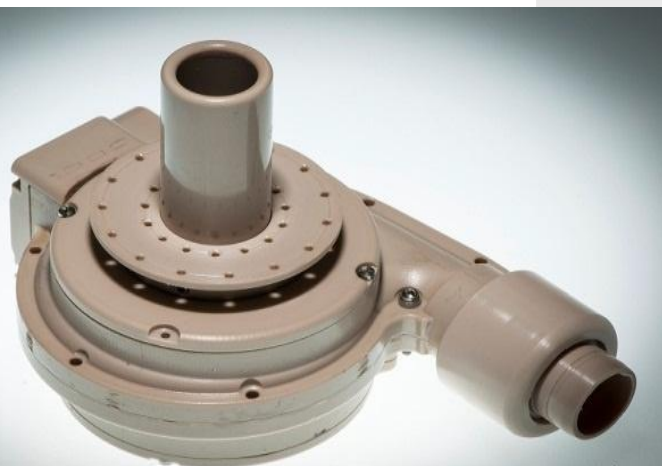
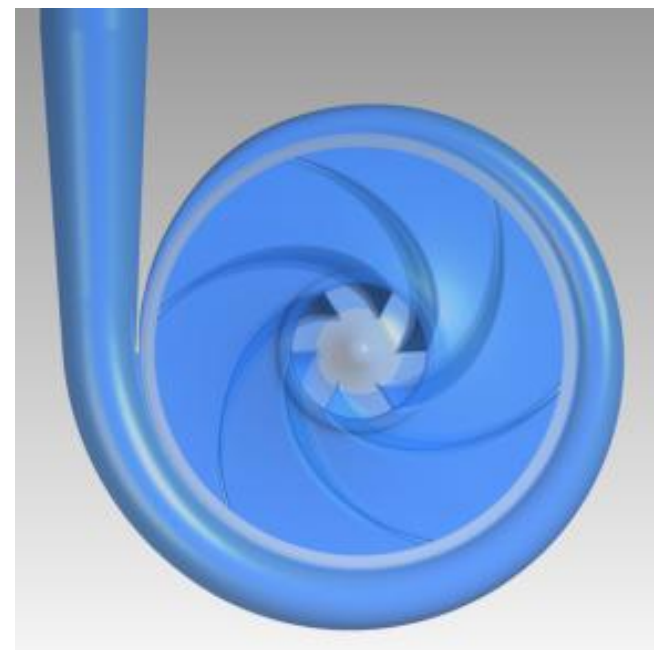
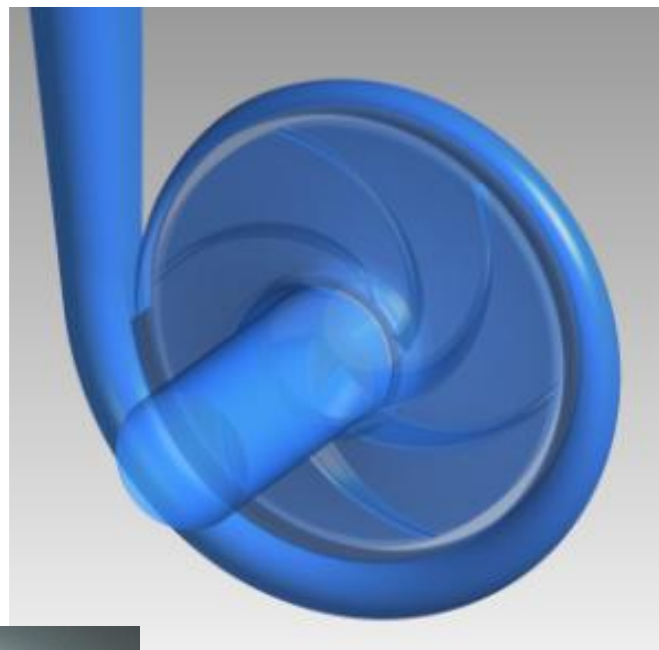

M-ERA.NET Transnational Call 2014

Project Acronym: bioVALVE

Partners:

JOANNEUM RESEARCH Forschungsges.m.b.H., Institute for Surface Technologies and Photonics, Austria;

Polish Academy of Sciences Institute of Metallurgy and Materials Science in Cracow, Poland;

Collegium Medicum of Jagiellonian University Cracow, Poland;

Foundation for Heart Surgery Development, Poland;

Chirmed Sp. z o.o. Poland

The aim of project bioVALVE was to life-threatening thrombo-embolii formation in pulsatile assist devices by *a new biomimetic*

heart valve design



Optimisation

Optimization of mechanical properties and determination of fluid dynamics based on finite element methods for flexible heart valves

A: Transient Structural
Total Deformation
Type: Total Deformation
Unit: mm
Time: 1
2017-11-20 15:34

0,71828 Max
0,63856
0,55874
0,47882
0,39911
0,31928
0,23946
0,15964
0,07982
0 Min

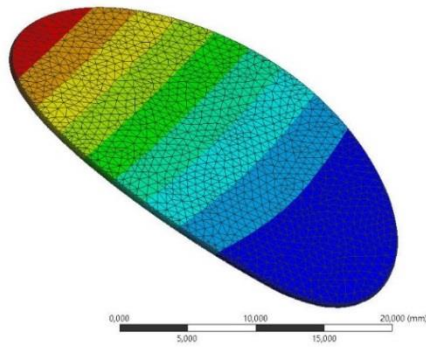

B: Transient Structural
Total Deformation
Type: Total Deformation
Unit: mm
Time: 1
2017-11-20 15:32

3,6934 Max
3,2297
2,826
2,4223
2,0186
1,6148
1,2111
0,80742
0,40371
0 Min

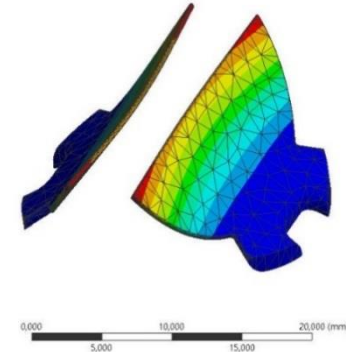

An example drawing of stress simulations in an inflow valve

An example drawing of stress simulations in an outflow valve

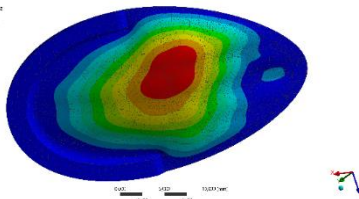
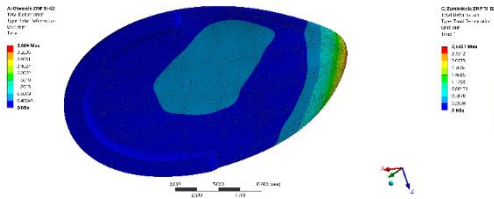

Strain of the inflow petal (Ti mesh) a- opened b- closed

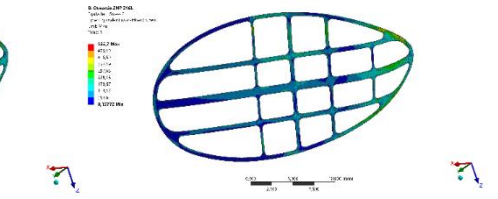
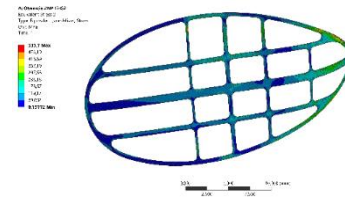

Stress in the inflow petal mesh a- Ti b- Steel

Optimization of mechanical properties and determination of fluid dynamics based on finite element methods for flexible heart valves

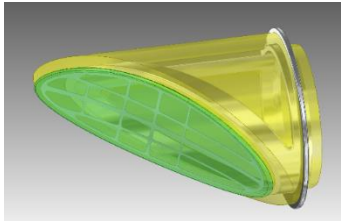

Inflow valve and cross-section through the area of the inflow channel.

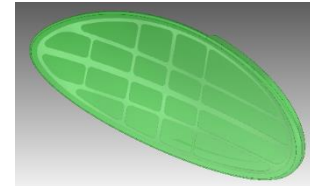
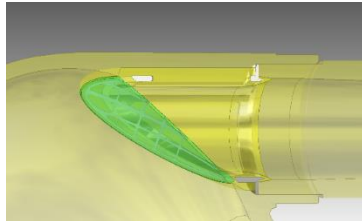

a - Petal with embedded reinforcing mesh

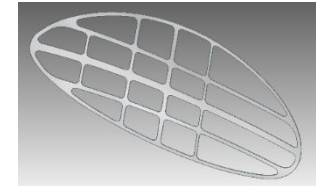

b - titanium reinforcing mesh

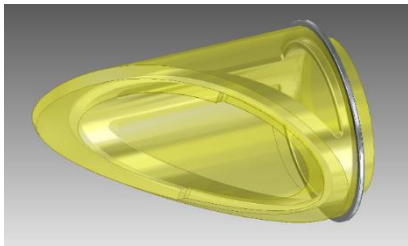

The carrier ring of the petal

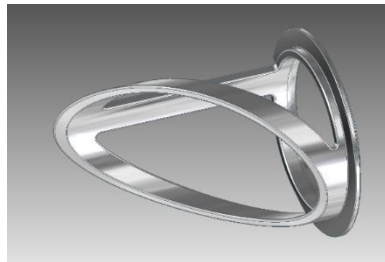

The frame of the ring

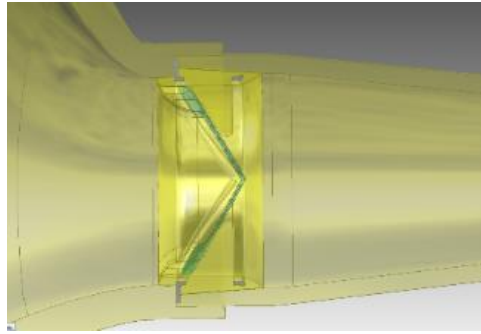
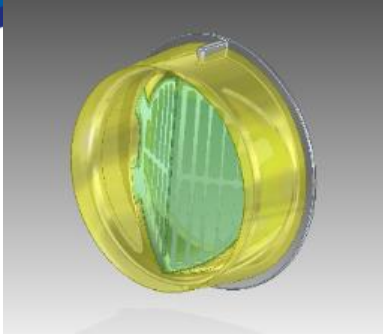

Polyurethane inflow valve and cross section through the outflow channel.



a - Valve ring: view from the outflow side

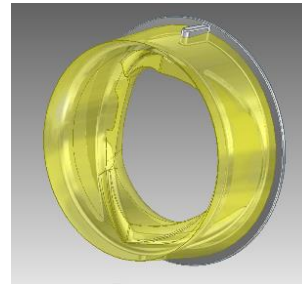

b - Valve ring: general view

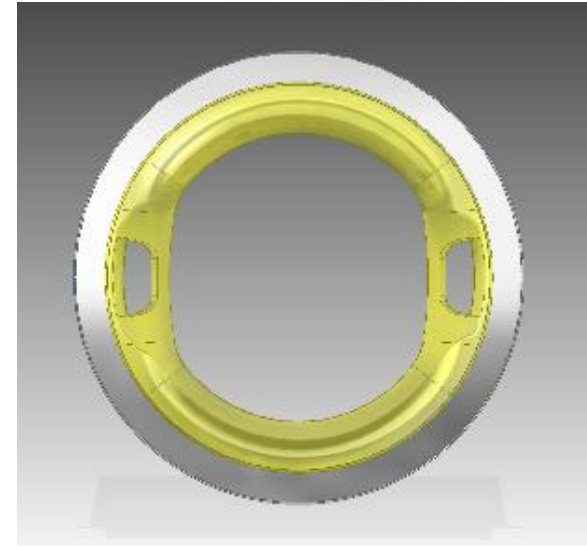

c - Valve ring; view from the inflow side



The frame of the ring

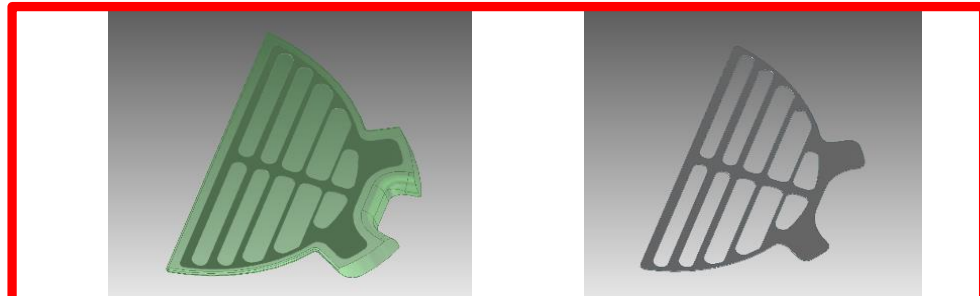

Polyurethane flake with covered frame

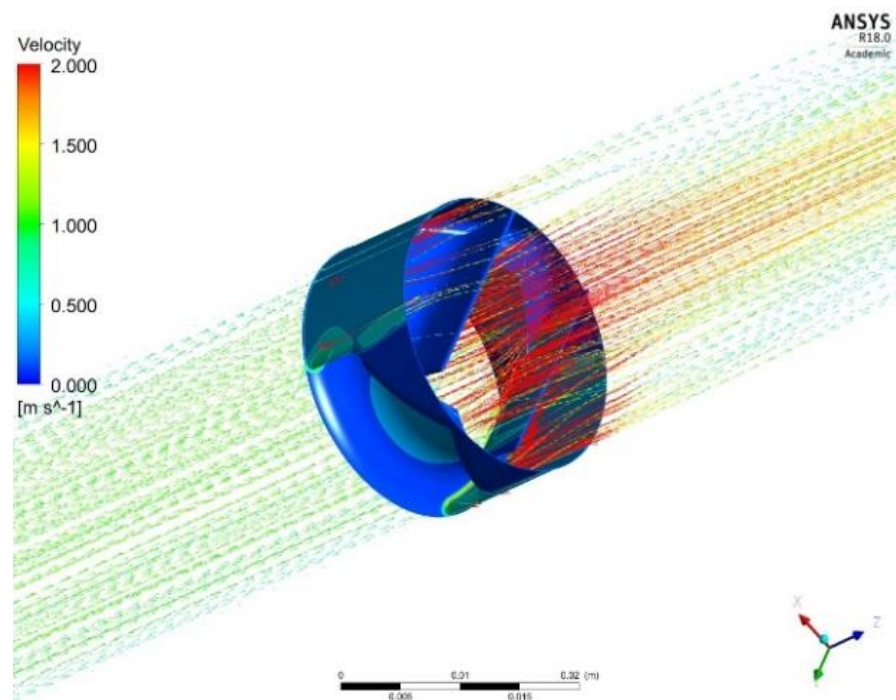
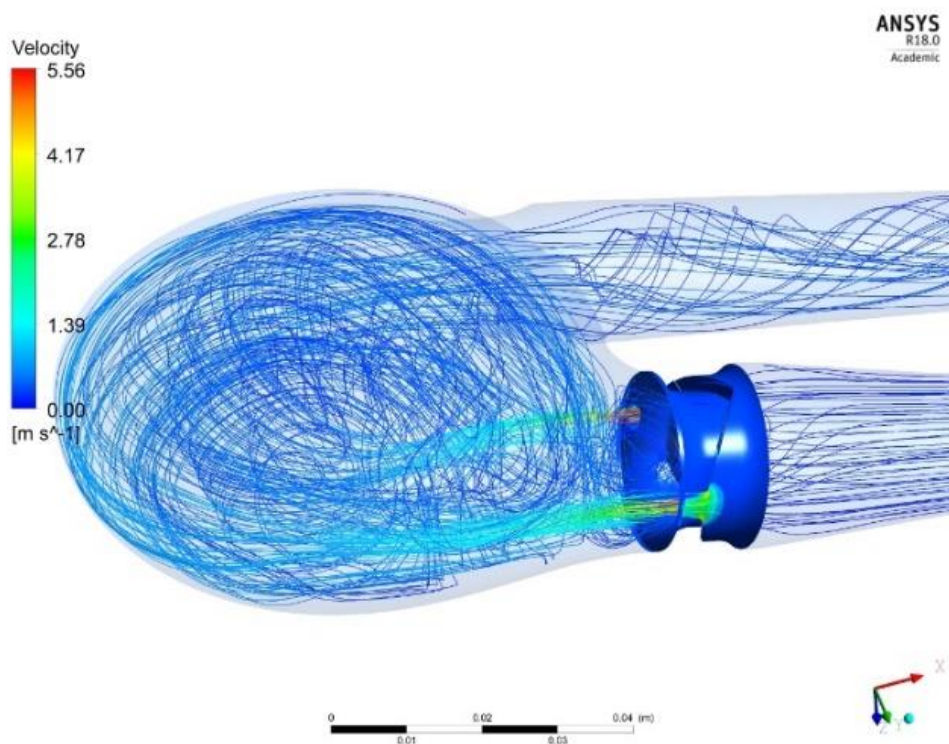

An example drawing of a flow velocity simulation (a) through a outflow valve in a ReligaHeart® heart assist pump equipped with new valve: (b) backflow flushing holes

From the course of the hysteresis loop or individual load cycles it follows that as the stress on a particular step increases, the shape of the loop and their surface change significantly. The larger area of the loop indicates high damping.

The need for reinforcement of the valve through a metal scaffold

On the basis of the dynamic creep curve presented in it is stated that the total creep $\Delta\varepsilon$, defined as the sum of delayed elastic strain ε_b and material flow ε_c , for the tested material was about 5.5 %. To the group of significant factors influencing the creep of the material should be not only the size of the load being applied and the duration of the test, but also the temperature and the environment in which the sample is located.

Analysis of defects (adjuacement- MESH WITHOUT DEFECTS)



(a)

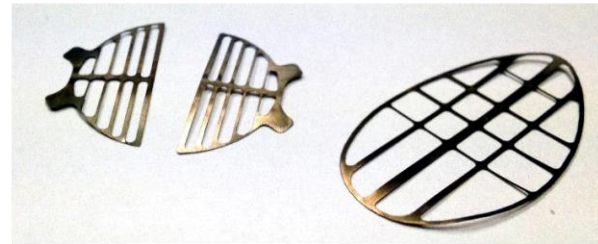

(b)

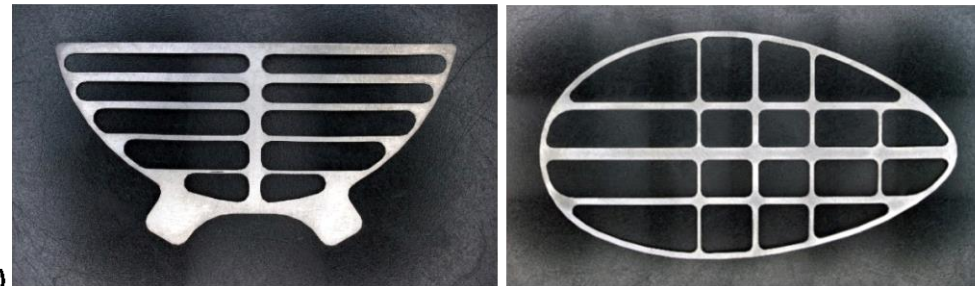

Metallic meshes pressed in PU

inflow valve

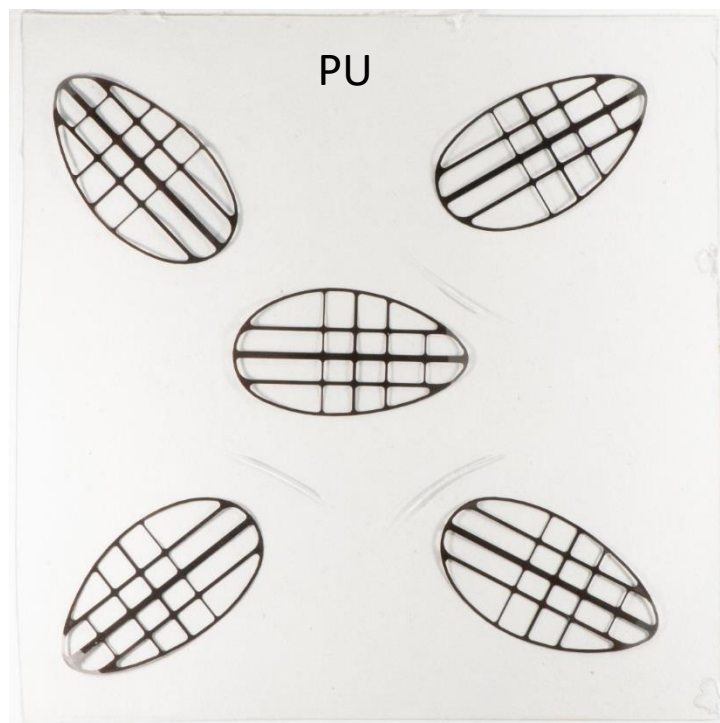

outflow valve

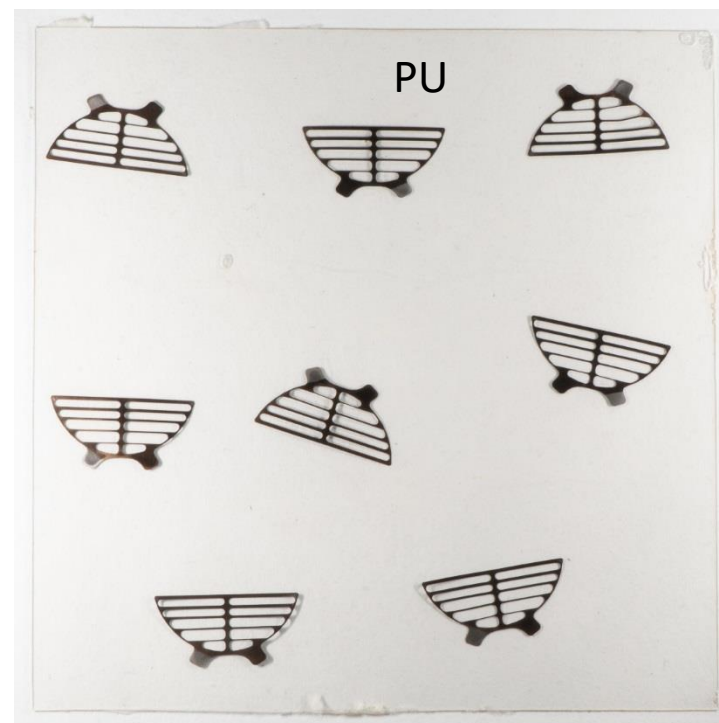

Valve flaps covered with polymer

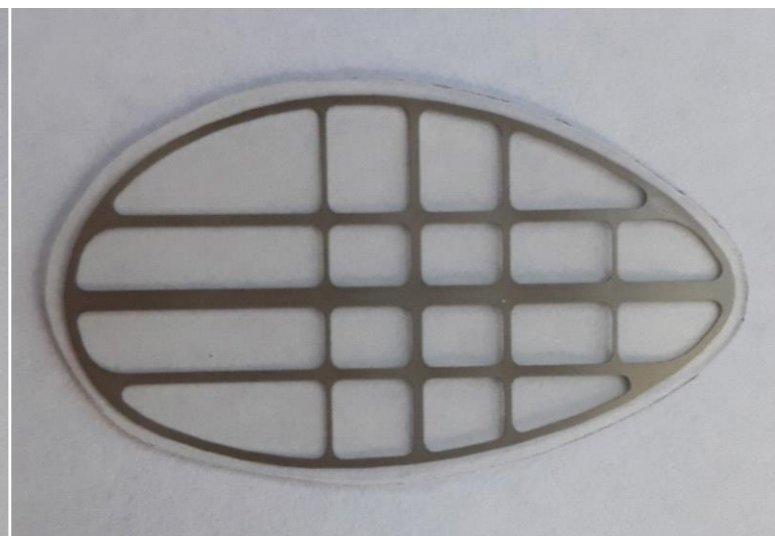

Rings dedicated for inflow and outflow valve- DRAWING

inflow valve



outflow valve



Rings dedicated for inflow and outflow valve- IM PROCESS

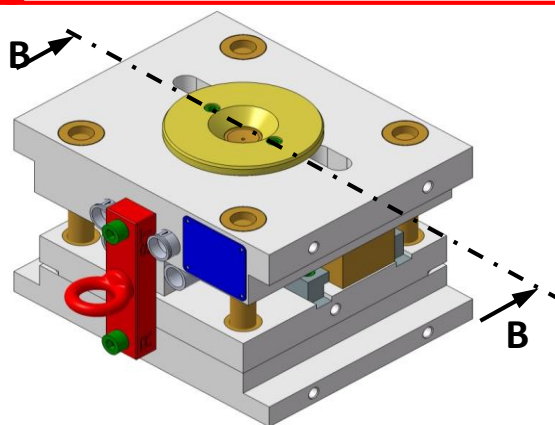

Research Form INFLOW VALVE

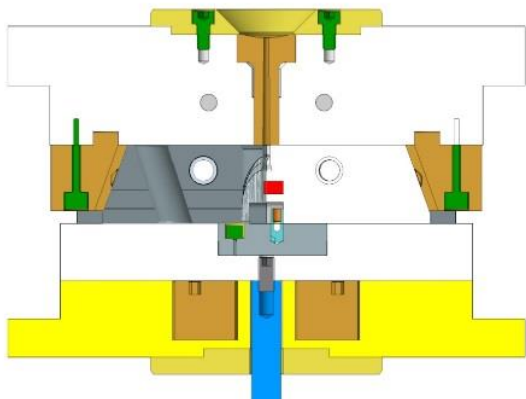

Shape concept of
component INFLOW VALVE



Research form OUTFLOW VALVE

Inflow valve- PRODUCT



**The need for improvement of the
metal scaffold surface with
hemocompatible, coatings
additionally improving METAL- PU
adhesion!**

R&D on surface coating deposition

Liferschein 2016096

Oznaczenie	Skład						Grubość [nm]	Przygotowanie	Atmosfera gazowa [sccm]	Chropowatość Ra [nm]	Kąt zwilżania	Energia powierzchniowa		
	a-C:H	a-C:H:N	a-C:N	ta-C:H	ta-C:H:N	Si - a-C:H						polar	dispers	Summe
B334_7				x			92,2	lonenquelle	20,0 C ₂ H ₂		79,9	3,5	40,0	43,4
B334_8				x			48,0	lonenquelle	20,0 C ₂ H ₂		78,3	3,5	42,4	45,9
B334_10				x			67,4	lonenquelle	20,0 C ₂ H ₂		79,7	3,3	41,4	44,6
B334_12				x			90,8	lonenquelle	5,0 Ar + 15,0 C ₂ H ₂		84,0	2,1	40,8	43,0
B372_6	x						94,7	sputtern	24,0 Ar + 6,0 C ₂ H ₂	14,7	60,82	9,68	46,74	56,43
B372_7		x					103,8	sputtern	24,0 Ar + 4,5 C ₂ H ₂ + 1,5 N ₂	14,2	58,53	10,17	48,82	58,99
B372_8		x					103,1	sputtern	24,0 Ar + 3,0 C ₂ H ₂ + 3,0 N ₂	12,7	57,83	11,55	45,54	57,09
B372_9		x					95,2	sputtern	24,0 Ar + 1,5 C ₂ H ₂ + 4,5 N ₂	24,0	53,03	13,70	46,55	60,25
B372_10			x				95,2	sputtern	24,0 Ar + 6,0 N ₂	19,0	45,90	17,14	47,45	64,59
B372_15				x			94,7	lonenquelle	20,0 C ₂ H ₂	13,0	41,87	20,94	43,6	64,54
B372_16					x		110,2	lonenquelle	17,5 C ₂ H ₂ + 2,5 N ₂	23,3	25,37	30,09	41,61	71,70
B372_17					x		100,3	lonenquelle	15,0 C ₂ H ₂ + 5,0 N ₂	12,7	32,63	24,61	45,87	70,49
B372_18					x		82,7	lonenquelle	12,5 C ₂ H ₂ + 7,5 N ₂	14,3	38,80	25,99	36,90	62,89
B372_23						x	124,3	sputtern	28,2 Ar + 1,8 C ₂ H ₂	16,3	27,80	27,07	45,35	72,42
B372_24						x	15,0	sputtern	28,2 Ar + 1,8 C ₂ H ₂	41,3	22,93	29,66	44,17	73,83
B372_25						x	127,6	sputtern	27,0 Ar + 3,0 C ₂ H ₂	19,2	19,37	29,47	46,89	76,36
B372_26						x	15,0	sputtern	27,0 Ar + 3,0 C ₂ H ₂	38,3	25,97	29,98	41,36	71,33
B372_27						x	123,5	sputtern	24,0 Ar + 6,0 C ₂ H ₂	26,2	24,35	27,62	47,07	74,69
B372_28						x	15,0	sputtern	24,0 Ar + 6,0 C ₂ H ₂	27,7	23,33	30,11	43,05	73,16
B372_29						x	118,5	sputtern	18,0 Ar + 12,0 C ₂ H ₂	14,0	54,33	11,98	49,66	61,64
B372_30						x	15,0	sputtern	18,0 Ar + 12,0 C ₂ H ₂	52,7	51,17	14,28	47,68	61,96

Group	Symbol	Layer	Thickness [nm]
1	B372_6	a-C:H	94,7
	B372_7	a-C:H,N	103,8
	B372_8	a-C:H,N	103,1
	B372_9	a-C:H,N	95,2
	B372_10	a-C:N	95,1
2	B372_15	a-C:H	94,7
	B372_15+E059	a-C:H+SF6 (fluoridation)	94,7
	B372_16	a-C:H,N	110,3
	B372_17	a-C:H,N	100,3
	B372_17+E059	a-C:H,N+SF6 (fluoridation)	100,3
3a	B372_18	a-C:H,N	82,7
	B372_23	Si/a-C:H	124,3
	B372_25	Si/a-C:H	127,6
	B372_27	Si/a-C:H	123,5
3b	B372_29	Si/a-C:H	118,5
	B372_24	Si/a-C:H	15
	B372_26	Si/a-C:H	15
	B372_28	Si/a-C:H	15
	B372_30	Si/a-C:H	15

R&D on surface coating deposition

Whole human blood dynamic tests

Blood-Material
Interaction



ELSEVIER

Biomolecular Engineering 19 (2002) 91–96

Biomolecular
Engineering

www.elsevier.com/locate/genenbioeng

In vitro hemocompatibility testing of biomaterials according to the
ISO 10993-4

Ulrich Theo Seyfert^{a,*}, Volker Biehl^b, Joachim Schenk^a

^a Abteilung Klinische Hämostaseologie und Transfusionsmedizin, Haus 75, Universitätskliniken, D-66421 Homburg, Germany

^b Universität des Saarlandes, Lehrstuhl für Metallische Werkstoffe, Im Stadtwald, D-66123 Saarbrücken, Germany

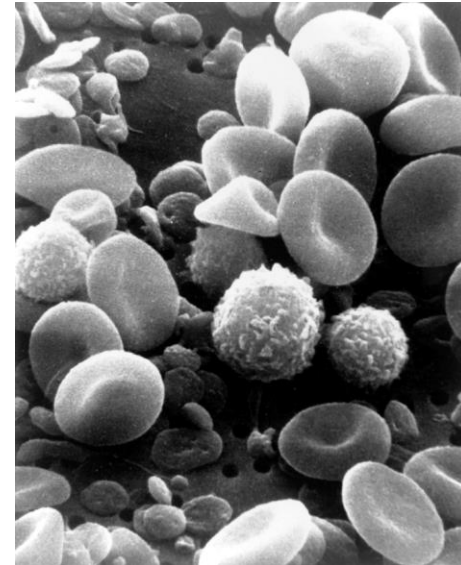

“A hemocompatible material must not adversely interact with any blood component”

R&D on surface coating deposition

Blood-Material
Interaction

- Human blood (4 x 4.5 mL)
- ADP activation 5 min.
- Arterial flow condition simulation.
- 130 μ L after the test.

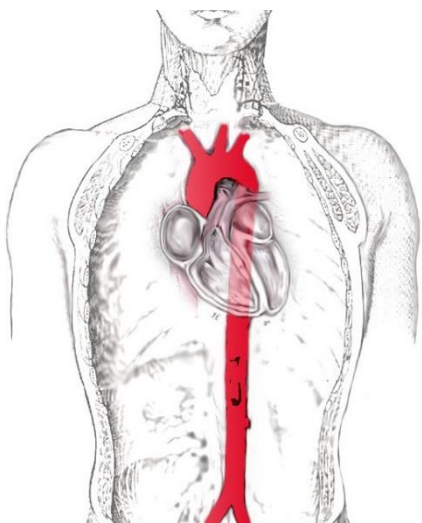

Arterial flow conditions on the flat surfaces

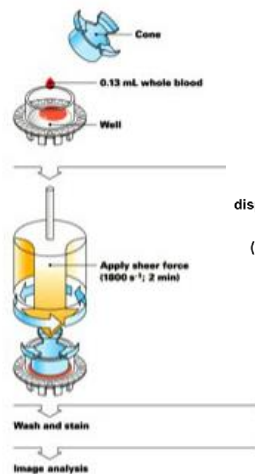

Impact R test

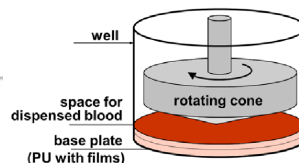

The blood-material interaction performed
under the high shear stress conditions

R&D on surface coating deposition

Haemocompatibility in dynamic conditions

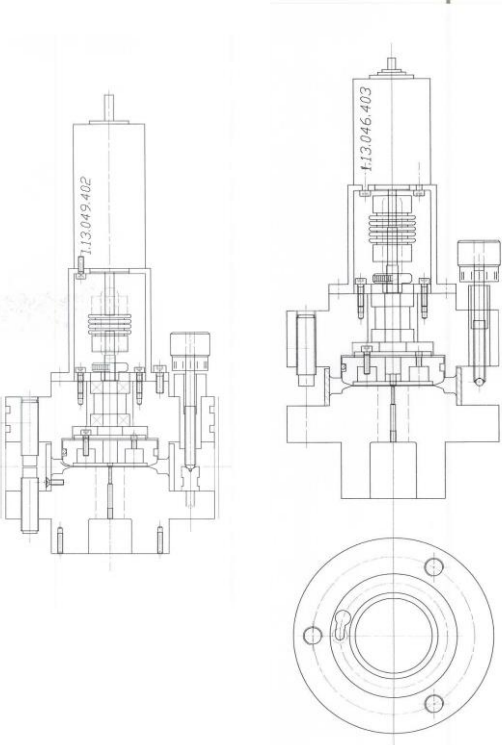

High speed rotor 3000-5000 rpm

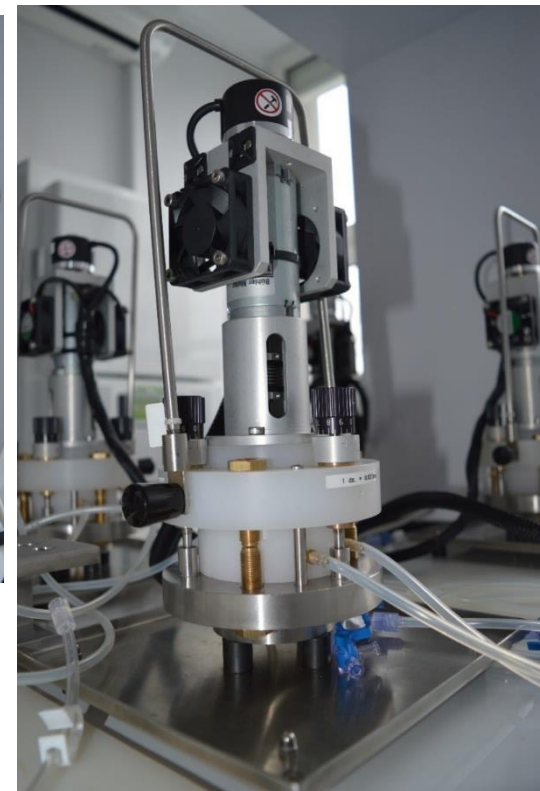

Material Engineering in Regenerative Cardiac Surgery: "Yesterday and Today"

Roman Major

r.major@imim.pl

Marcin Surmiak, Marek Sanak, Maciej Gawlikowski, Roman Kustosz,
Łukasz Major, Hanna Plutecka, Przemysław Kurtyka, Juergen M. Lackner, Bogusław Major

deposition: P-selectin activation

Hemocompatibility in dynamic conditions

Blood-Material Interaction

P-selectin is protein that in humans is encoded by the SELP gene. P-selectin functions as a cell adhesive molecule

P-selectin-anti-selectin-P antibody

Integrin beta-3 (β3) encoded by the ITGB3 gene. CD61 is a cluster of differentiation found on thrombocytes.

negative	neutral
neutral	positive

Group	Symbol	Layer	Thickness (mm)
1	B372_6	a-C:H	94,7
	B372_7	a-C:H,N	103,8
	B372_8	a-C:H,N	103,1
	B372_9	a-C:H,N	95,2
	B372_10	a-C:N	95,1
2	B372_15	a-C:H	94,7
	B372_15+E059	a-C:H+SF6 (fluoridation)	94,7
	B372_16	a-C:H,N	110,3
	B372_17	a-C:H,N	100,3
	B372_17+E059	a-C:H,N+SF6 (fluoridation)	100,3
	B372_18	a-C:H,N	82,7
3a	B372_23	Si/a-C:H	124,3
	B372_25	Si/a-C:H	127,6
	B372_27	Si/a-C:H	123,5
3b	B372_29	Si/a-C:H	118,5
	B372_24	Si/a-C:H	15
	B372_26	Si/a-C:H	15
	B372_30	Si/a-C:H	15
	B372_30	Si/a-C:H	15

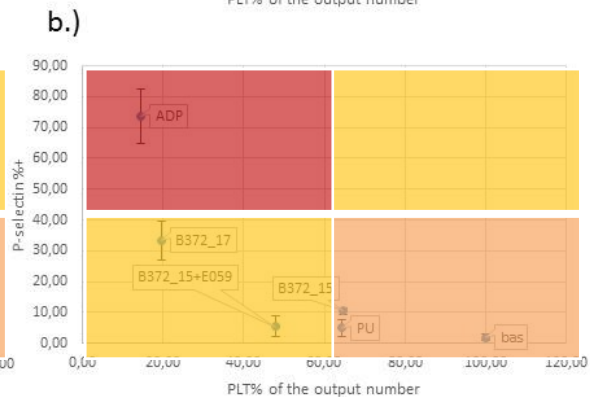
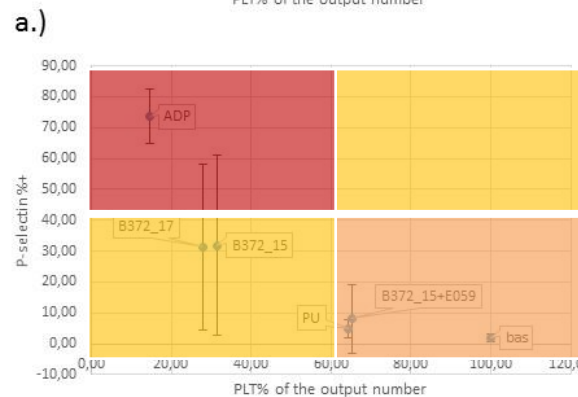
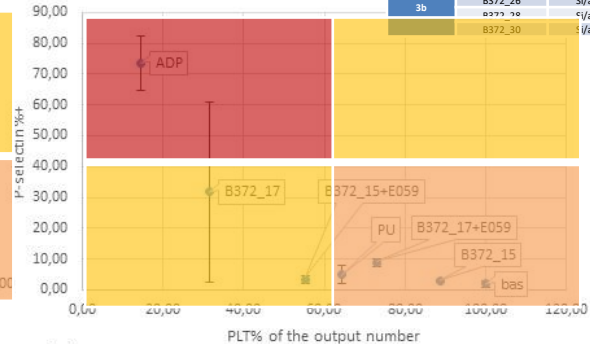
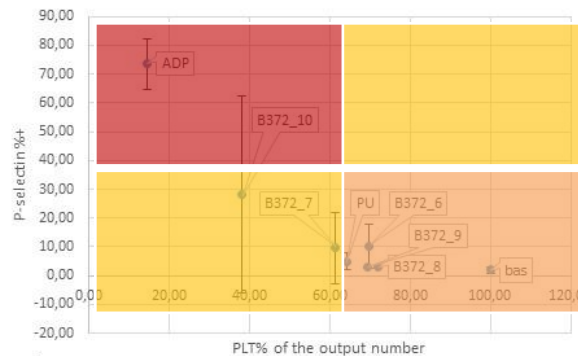

R&D on surface coating

R&D on surface coating deposition

Microparticles (MPs) are small membrane vesicles that are released by activated or apoptotic cells.

Blood-Material
Interaction

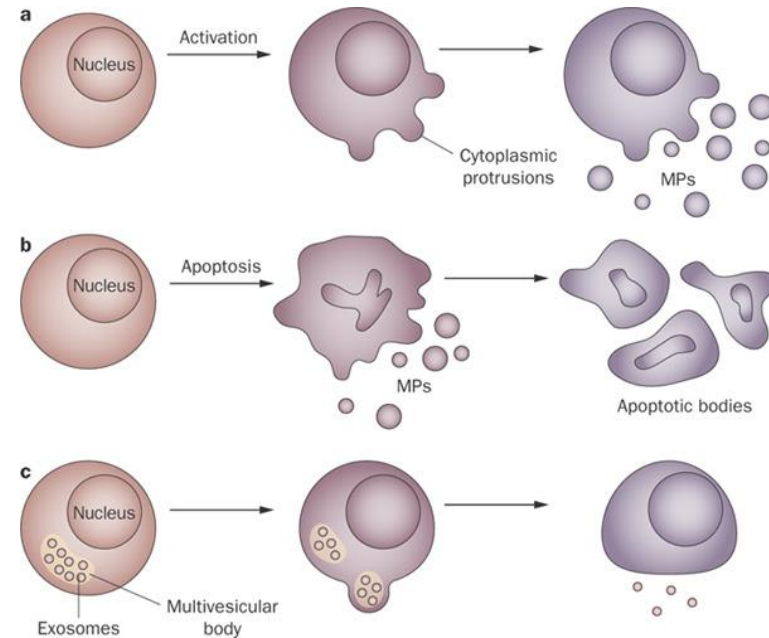
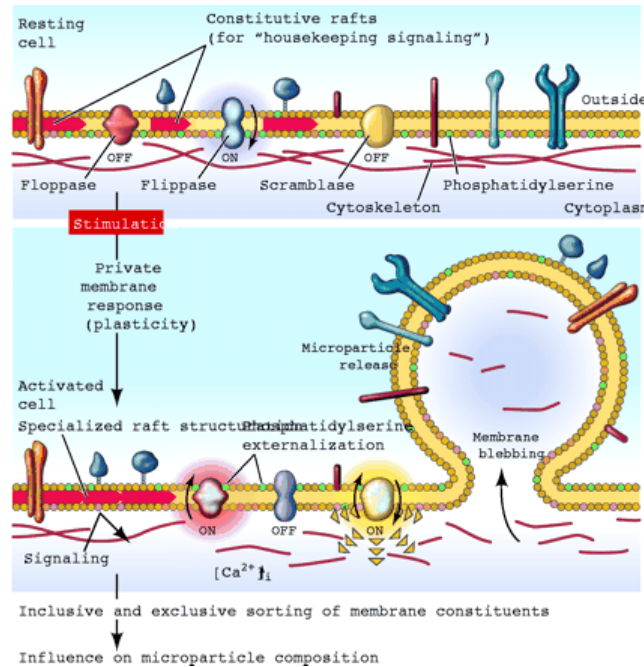

R&D on surface coating

R&D on surface coating deposition

negative	neutral
neutral	positive

Group	Symbol	Layer	Thickness (nm)
1	B372_6	a-C:H	94,7
	B372_7	a-C:H,N	103,8
	B372_8	a-C:H,N	103,1
	B372_9	a-C:H,N	95,2
	B372_10	a-C:N	95,1
2	B372_15	a-C:H	94,7
	B372_15+E059	a-C:H+SF6 (fluoridation)	94,7
	B372_16	a-C:H,N	110,3
	B372_17	a-C:H,N	100,3
	B372_17+E059	a-C:H,N+SF6 (fluoridation)	100,3
	B372_18	a-C:H,N	82,7
	B372_23	Si/a-C:H	124,3
3a	B372_25	Si/a-C:H	127,6
	B372_27	Si/a-C:H	123,5
	B372_29	Si/a-C:H	118,5
3b	B372_24	Si/a-C:H	15
	B372_26	Si/a-C:H	15
	B372_28	Si/a-C:H	15
	B372_30	Si/a-C:H	15

Haemocompatibility in dynamic conditions

Microparticles MP
[nm fosfatydyloserin]

Blood-Material
Interaction

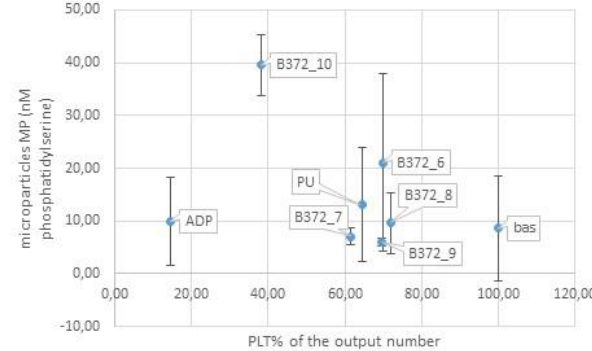

a.)

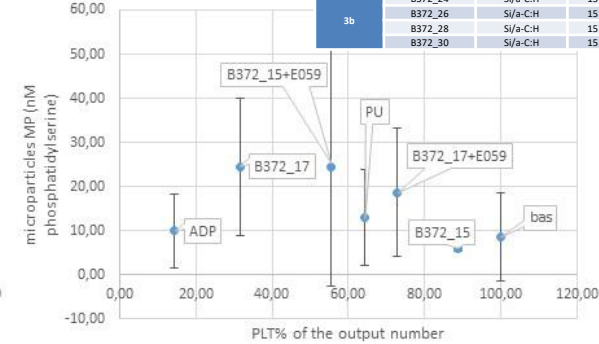

b.)

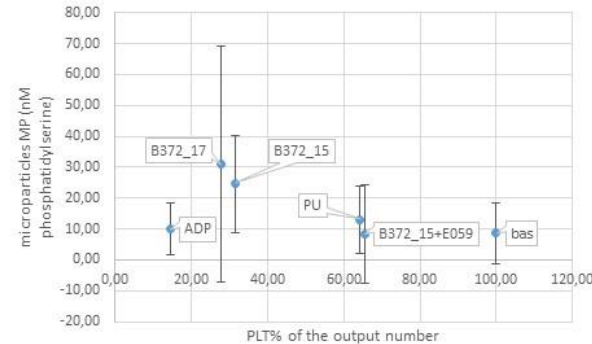

c.)

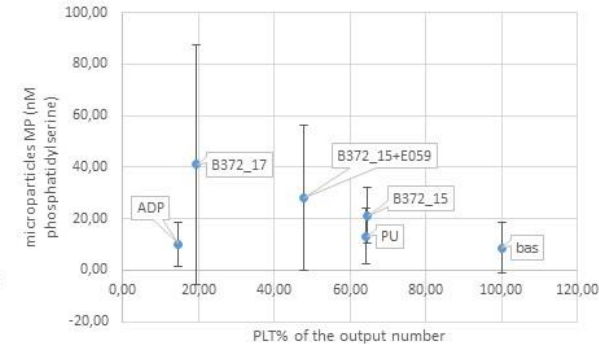

d.)

In vivo tests of „simple” samples



Reaction	Scoring irritation
Erythema formation	
No erythema	0
Very slight erythema	1
Well defined erythema	2
Moderate erythema	3
Severe erythema (dark red)	4
Edema formation	
Lack of edema	0
Very weak swelling (barely perceptible)	1
Well defined erythema (edges of the area well defined by elevation)	2
Moderate edema (elevation of about 1 mm)	3
Painful swelling (elevation above 1 mm goes beyond the area of exposure)	4
Maximum possible score	8



... exemplary image of the animal's skin 72h after injection.

The scale of evaluation of responses in intradermal reactivity tests

1- side of the animal's head, 2 injections of extract in polar solvent, 3 injections of pure polar solvent, 4 injections of the extract in a non-polar solvent, 5 injections of a pure non-polar solvent, 6 parts of the tail of the animal

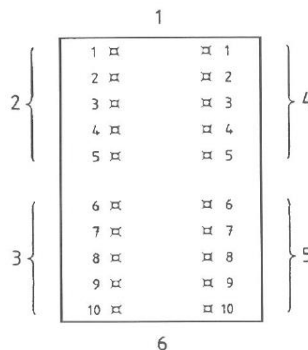

Intradermal reactivity - location of injection points (according to ISO 10993-10)
Intradermal reactivity - location of injection points (according to ISO 10993-10)

The test results showed that the tested material extracted with apolar and polar extract did not irritate the skin of rabbits during the 72 h observation period. The tested material met the test requirements because the difference between the average test score and the average control score was less than 1.0 (= 0.13) and in accordance with the normative guidelines ISO 10993-10 was considered non-irritating. It can be concluded that the tested material does not induce intradermal reaction.

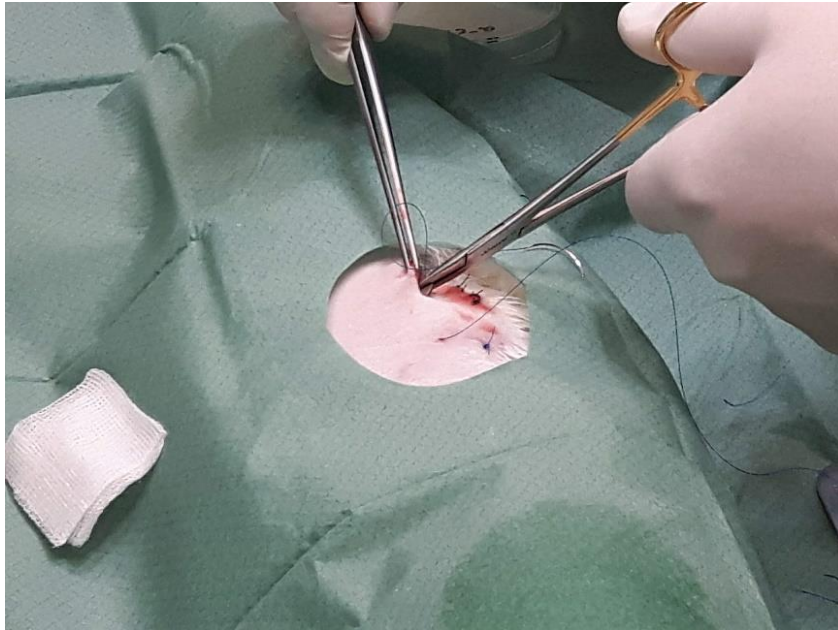

Placing the disc of the tested material under the skin on the back of the animal.



Study group, rabbit No. 2. Implanted site of implantation after 4 weeks, visible petechiae.

HISTOLOGY (liver, thymus, lung, myocardium)

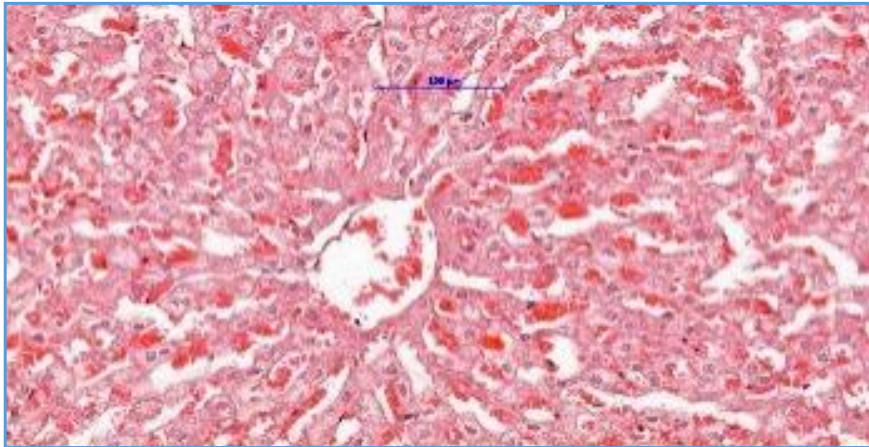

Correct liver lacunae. Mag. 200x

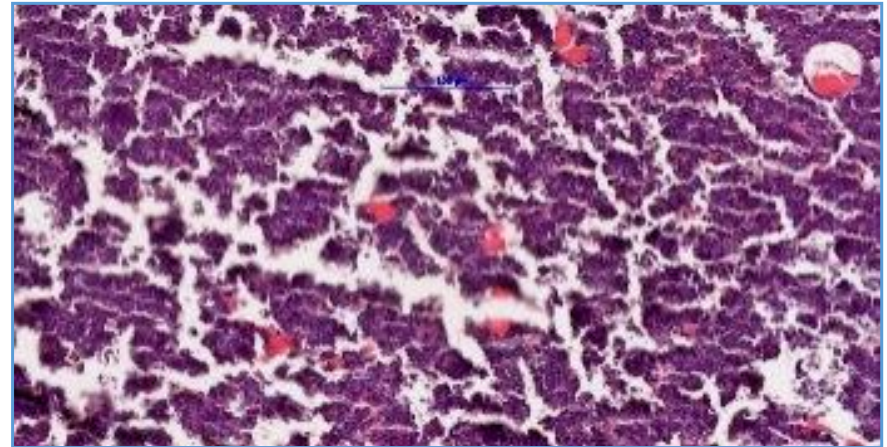

Proper thymic lacunae with Hassal's tiny pink bodies. Mag. 200x

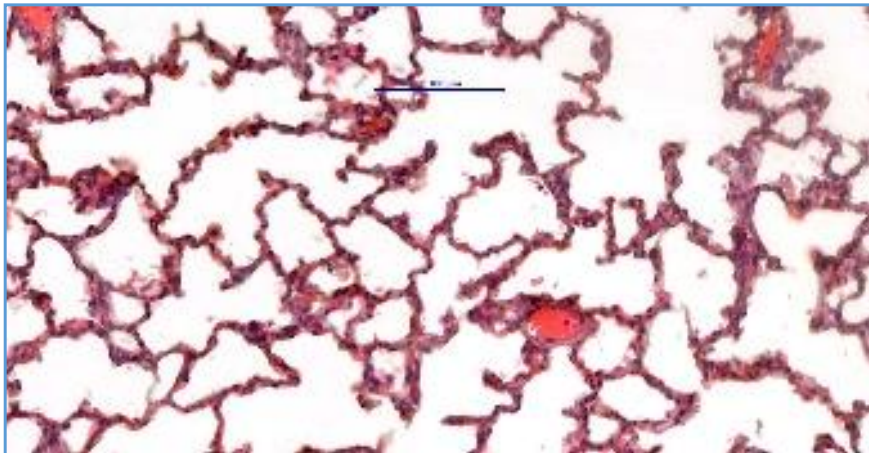

Properly aerated lung parenchyma. Mag. 200x

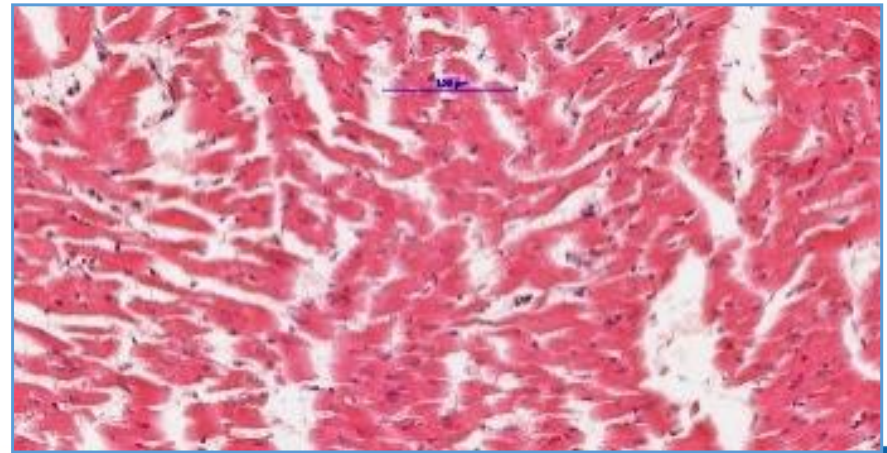

Correct binding of the myocardium. Mag. 200x

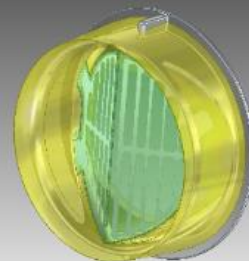
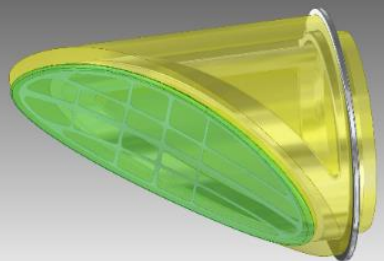



Presentation of the results of the project Single-piece miniature 4D rotor for blood pump

M-ERA.NET2 2017/4/2019

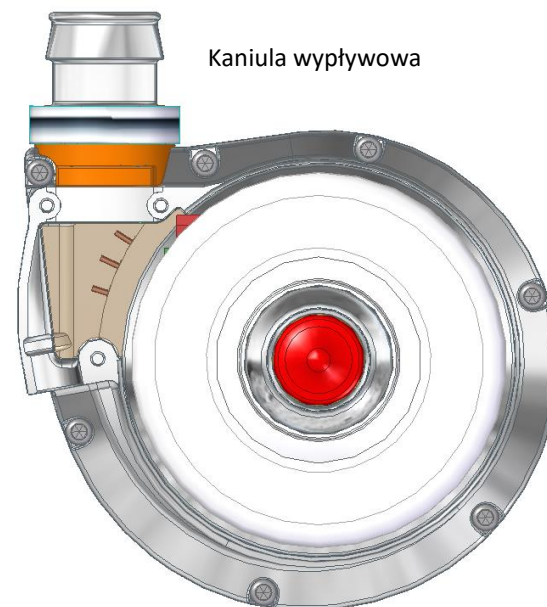
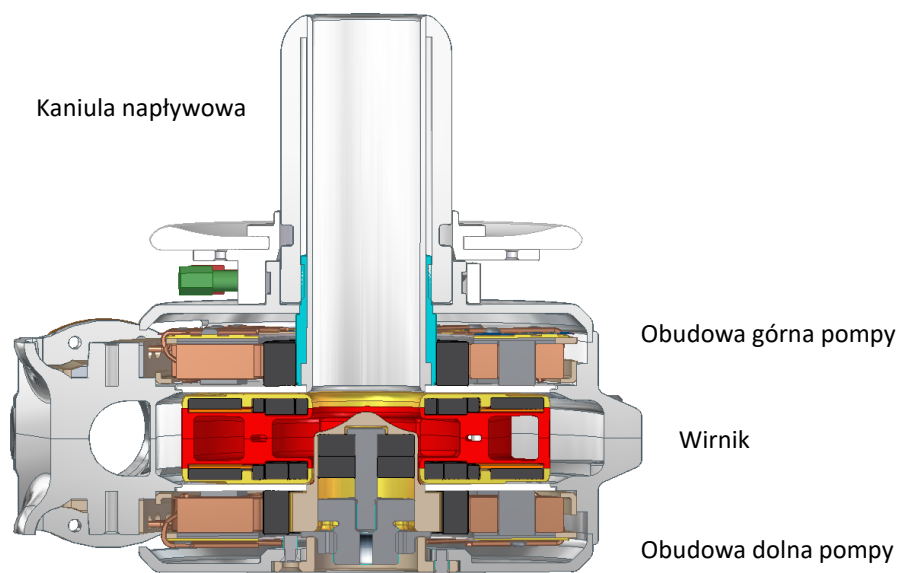

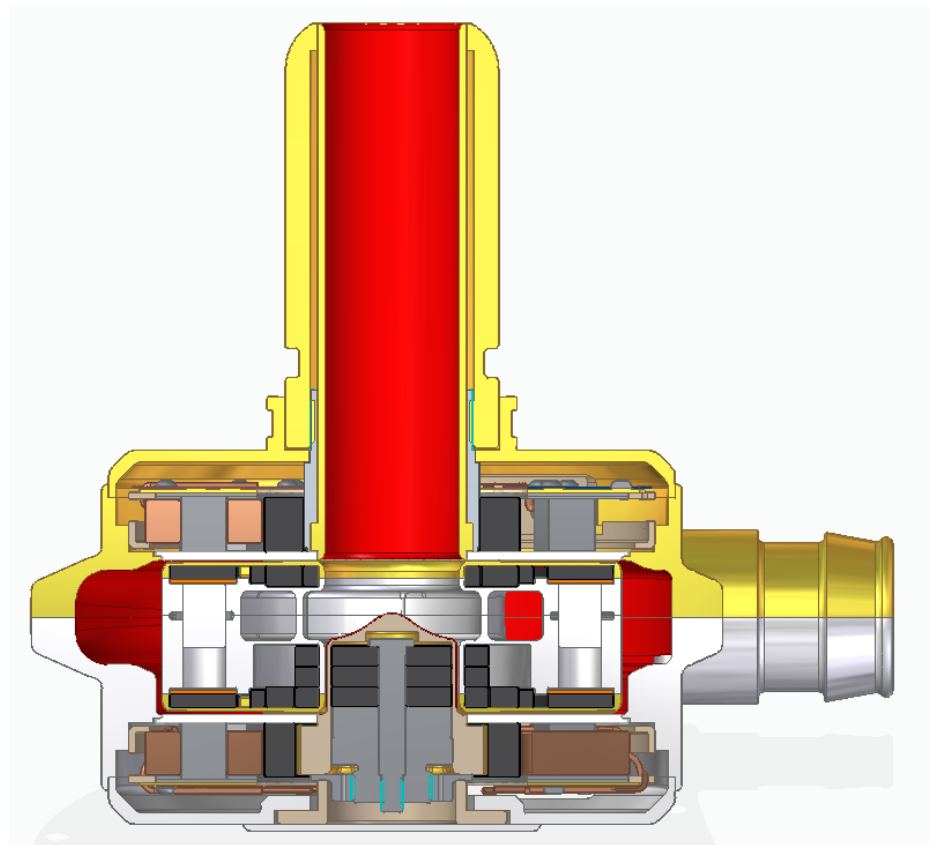
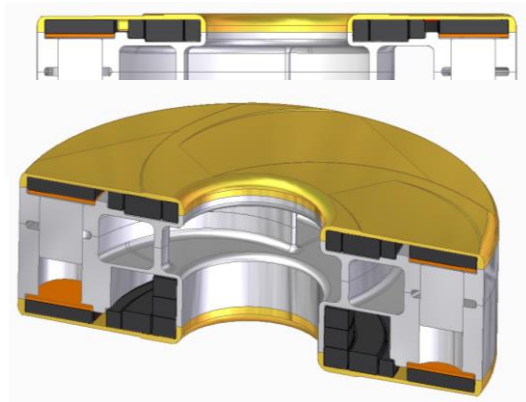

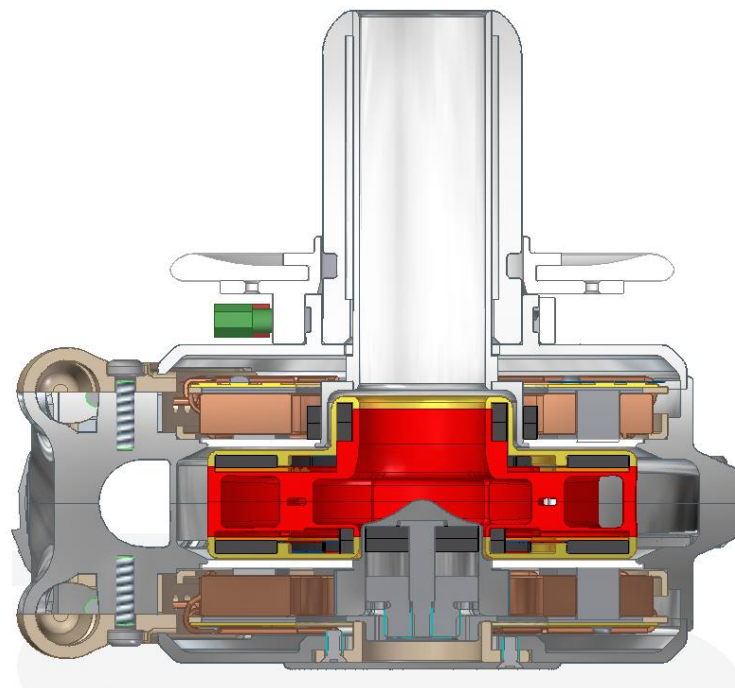
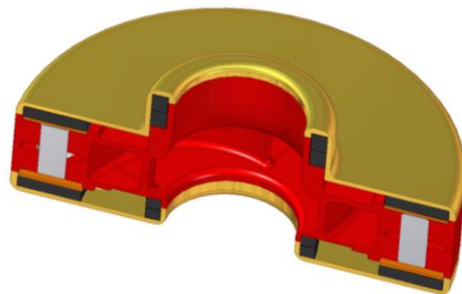
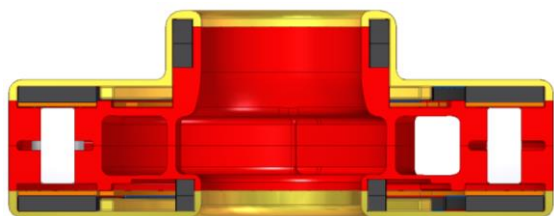

CAD – Dokumentacja konstrukcji wirnika pompy RH ROT MAGN z wirnikiem otwartym

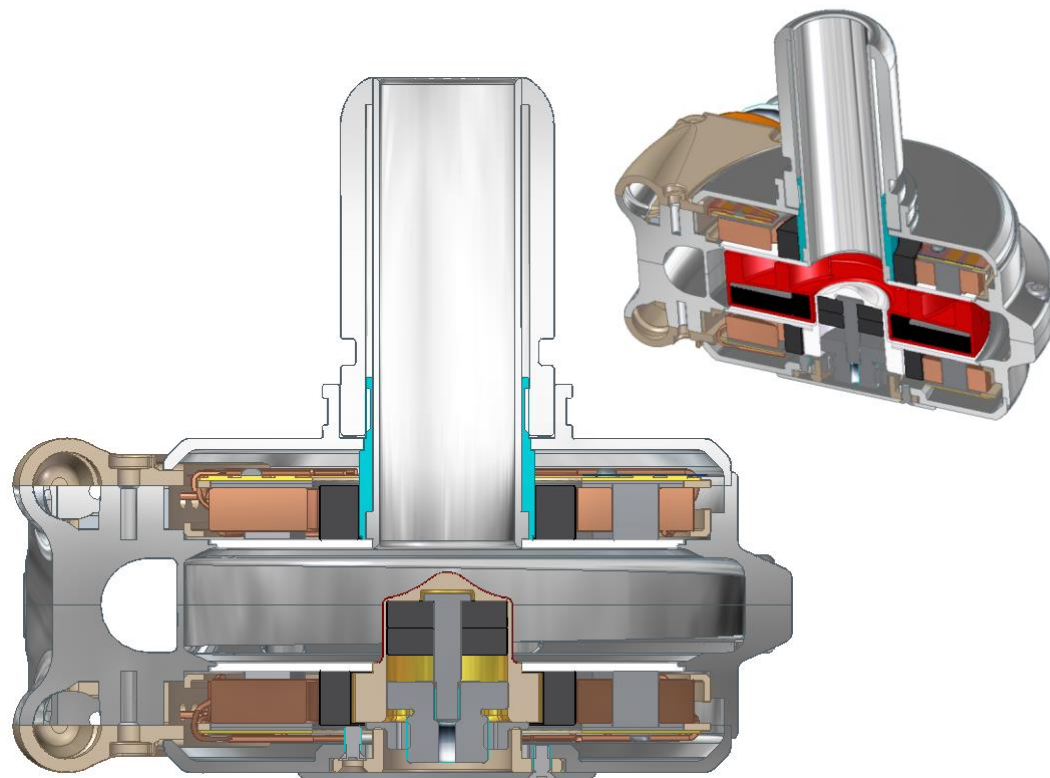
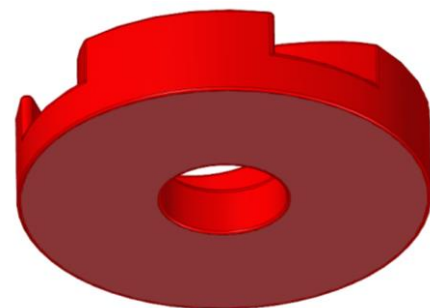
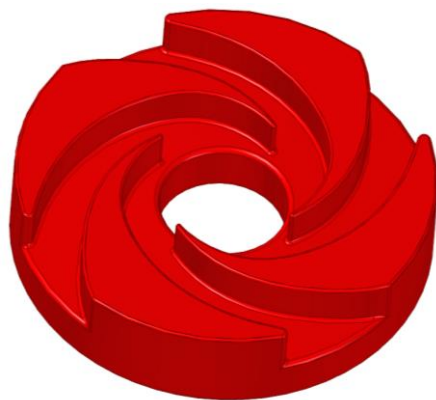

Obudowa pompy w wersji wejściowej konstrukcji nie wymaga istotnych modyfikacji w celu dostosowania do konstrukcji wirnika otwartego.

Nowa wersja wirnika otwartego

Monomer Synthesis

- **Di(prop-2-yn-1-yl) carbonate**

- MG = 138,12 g/mol

- 350 g (95% yield)

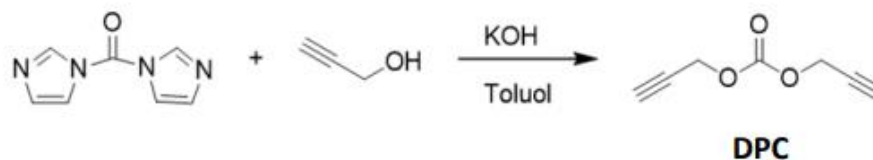

- **Di(but-3-yn-1-yl) carbonate**

- MG = 166,17 g/mol

- 350 g (98% yield)

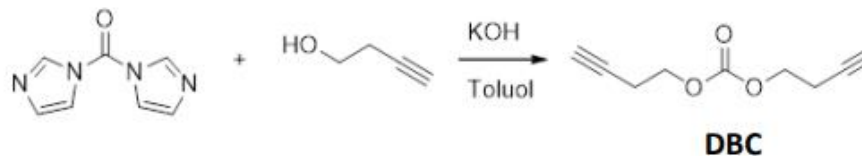

- **Bis (prop-2yn-1-yloxy) methan**

- MG = 124,14 g/mol

- 250 g (85% yield)

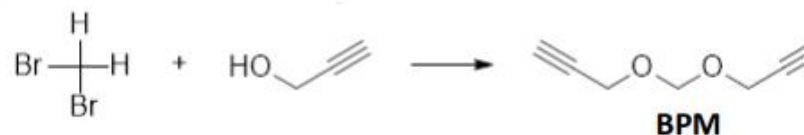

Evaluation of the Cytotoxicity in Dependence of Different Photoinitiators

Variation of photoinitiators:

TPO-L:	0,25 wt%	0,5 wt%	1 wt%
Irg-819:	0,25 wt%	0,5 wt%	1 wt%
Ivocerin:	0,25 wt%	0,5 wt%	1 wt%

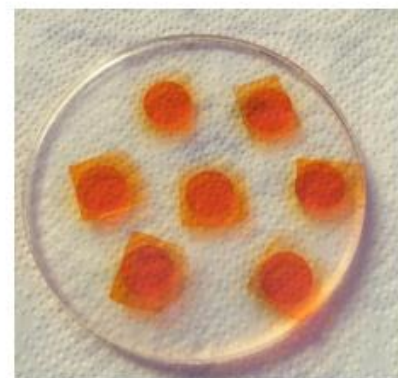

Monomer system:

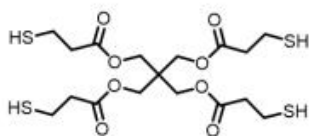

PETMP

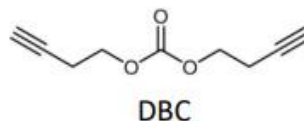

DBC

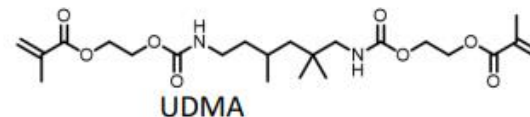

UDMA

Stabilizers:

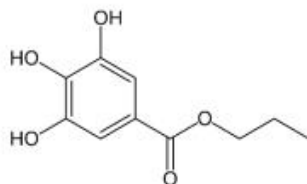

Propyl gallate (0,5 wt%)

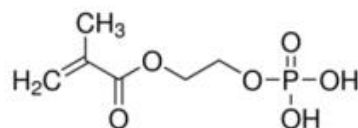

Mirammer A99 (2 wt%)

Indication	Description
Batch : BE_190321_2	Propyl gallat DBC = Di(but-3-yn-1-yl) carbonate PETMP UDMA Acrylat Miramer A99 0.25 wt% TPO-L
Batch : BE_190321_3	Propyl gallat DBC = Di(but-3-yn-1-yl) carbonate PETMP UDMA Acrylat Miramer A99 0.5 wt% TPO-L
Batch : BE_190321_4	Propyl gallat DBC = Di(but-3-yn-1-yl) carbonate PETMP UDMA Acrylat Miramer A99 1.00 wt% TPO-L
Batch : BE_190322_5	Propyl gallat DBC = Di(but-3-yn-1-yl) carbonate PETMP UDMA Acrylat Miramer A99 0.25 wt% 819 BAPO
Batch : BE_190322_6	Propyl gallat DBC = Di(but-3-yn-1-yl) carbonate PETMP UDMA Acrylat Miramer A99 0.5 wt% 819 BAPO
Batch : BE_190322_7	Propyl gallat DBC = Di(but-3-yn-1-yl) carbonate PETMP UDMA Acrylat Miramer A99 1.00 wt% 819 BAPO
Batch : BE_190322_8	Propyl gallat DBC = Di(but-3-yn-1-yl) carbonate PETMP UDMA Acrylat Miramer A99 0.25 wt% Ivocerin
Batch : BE_190322_9	Propyl gallat DBC = Di(but-3-yn-1-yl) carbonate PETMP UDMA Acrylat Miramer A99 0.5 wt% Ivocerin
Batch : BE_190322_10	Propyl gallat DBC = Di(but-3-yn-1-yl) carbonate PETMP UDMA Acrylat Miramer A99 1.00 wt% Ivocerin

10000 cells/well in 24 well plate



5 days culture to have ove division

Nuclei staining- CLSM

LDH- colorimetric

Luminex assay

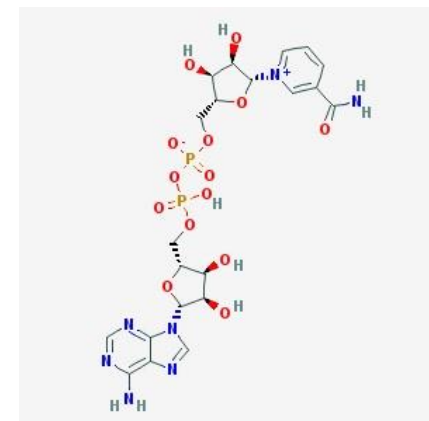
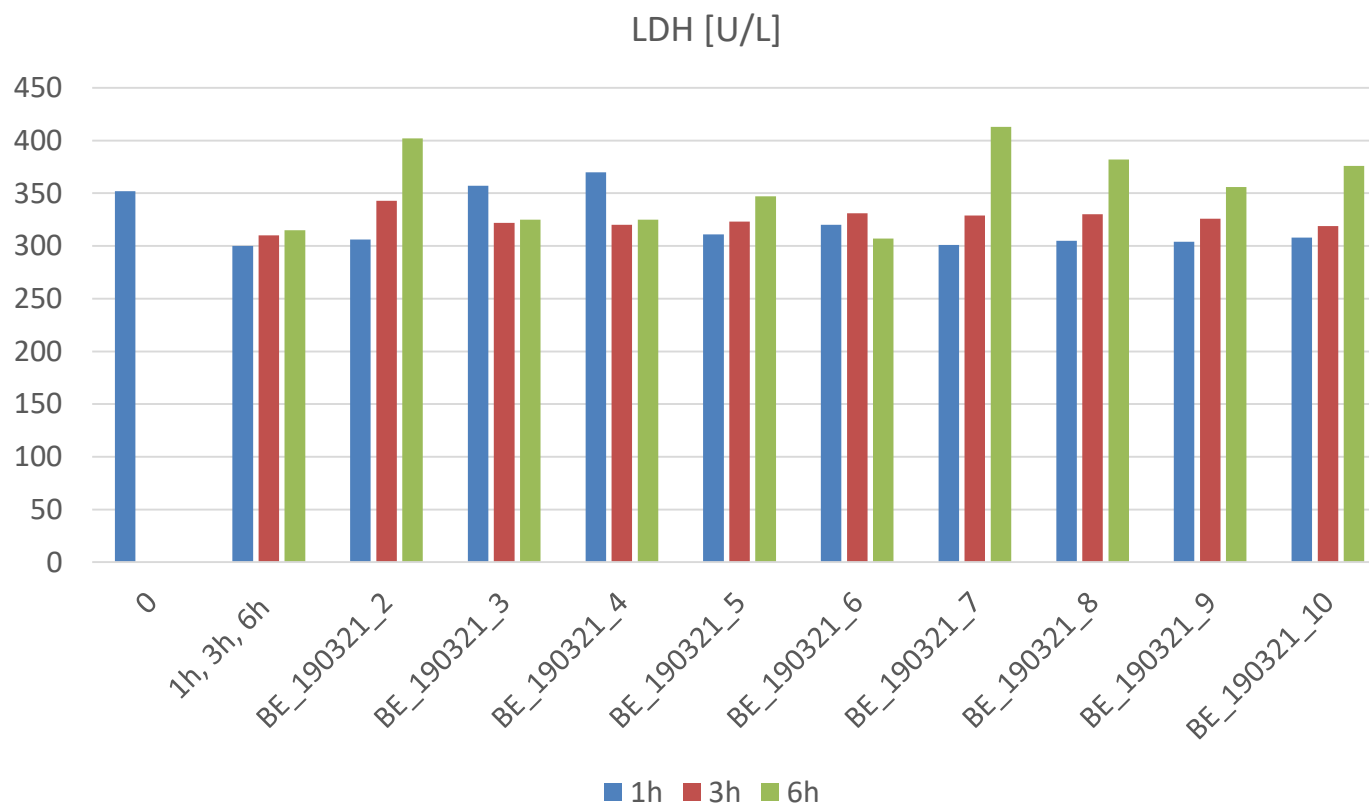

Construction of NAD

The basis of LDH test

LACTATE \longrightarrow PYRUVATE

NAD⁺ \longrightarrow NADPH+H⁺

TETRAZOLIN \longrightarrow FORMAZAN

Diaphoresis

MILLIPLEX® MAP 7-plex DNA Damage/Genotoxicity Magnetic Bead Kit (nr kat. 48-621MAG) to zestaw do jednoczesnego oznaczenia ilościowego następujących 7 analitów w lizatach komórkowych:

- ATR (total)
- Chk1 (Ser345)
- Chk2 (Thr68)
- H2A.X (Ser139)
- MDM2 (total)
- p21 (total)
- p53 (Ser15)

Sensor proteins like Rad9, Rad1 and Hus1

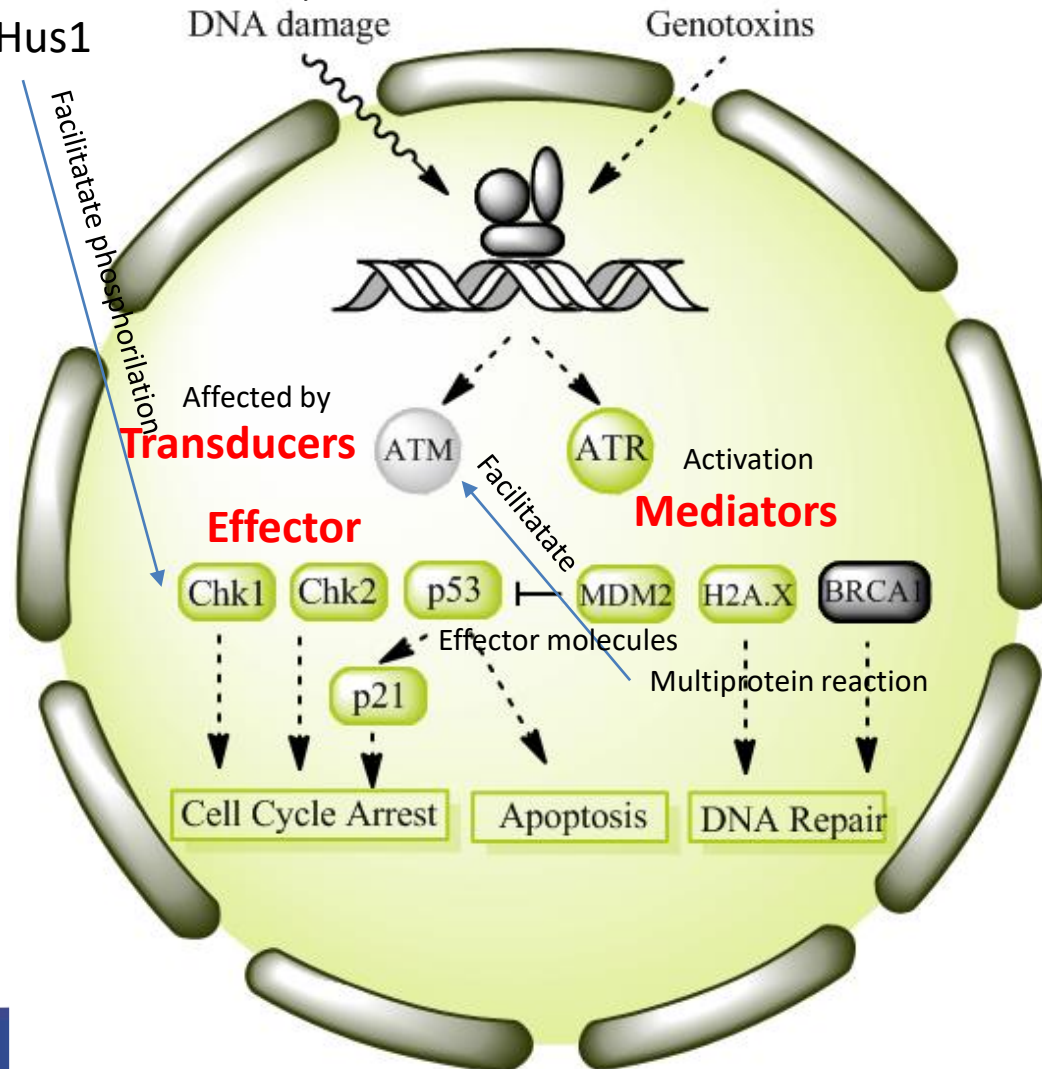

ATR

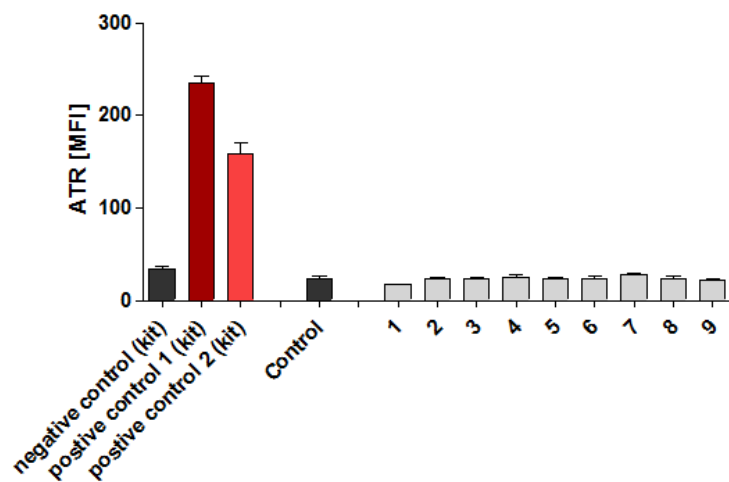

Chk1

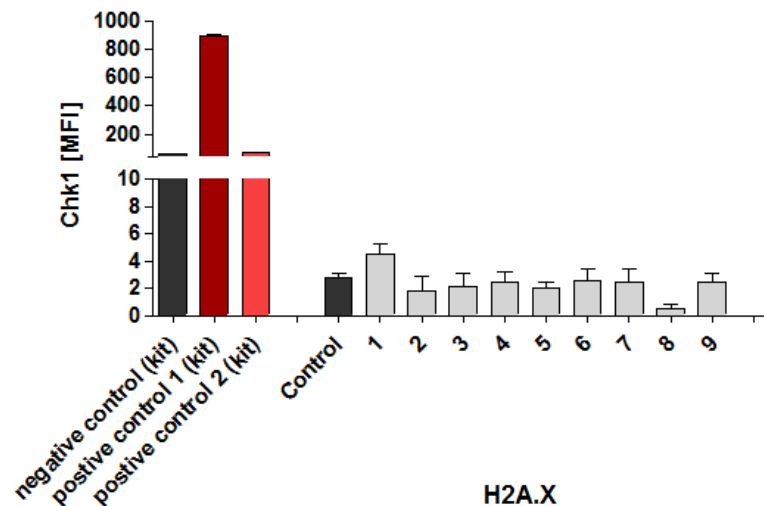

Chk2

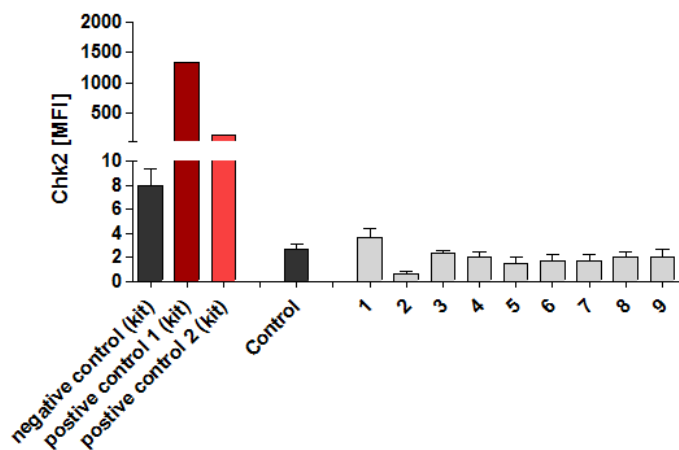

H2A.X

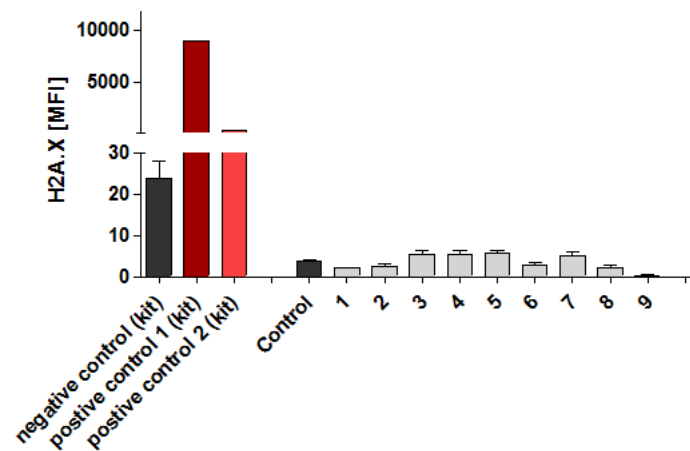

MDM2

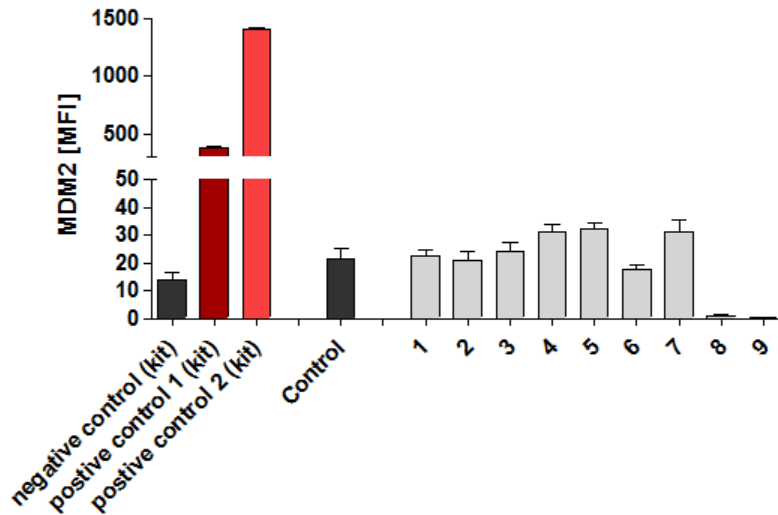

the main negative regulator of p53 in the cell - MDM2 protein

p21

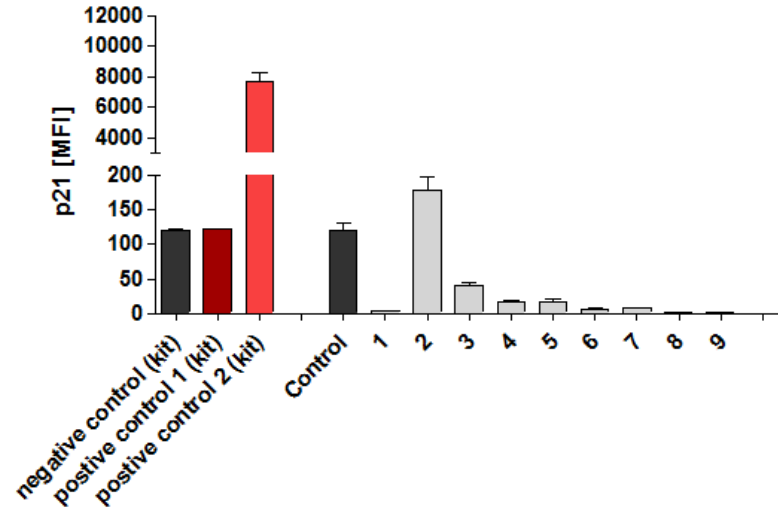

The p21 protein is a potent cyclin-dependent kinase inhibitor (CKI): it binds to the cyclin complexes CDK2 or CDK4, inhibiting their activity. It thus acts as a cell cycle regulator in the G1 phase.

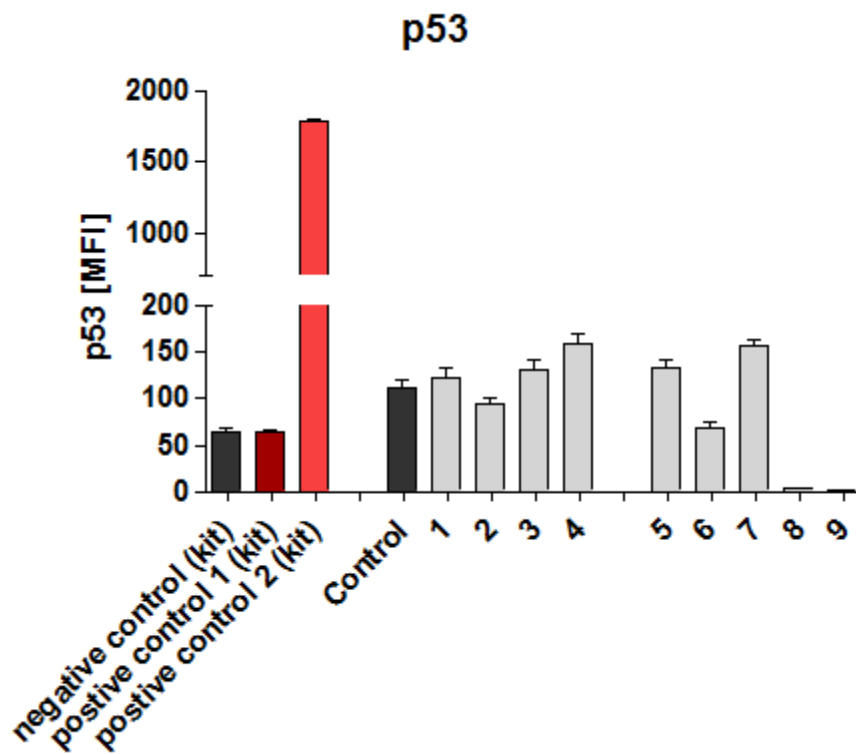

Blood-Material Interaction

Name	Composition	Application
M	CD61-PerCP, CD62P, PAC-1	assessment of platelet activation under the influence of contact with the material (+ control)
A	CD61-PerCP, CD62P, PAC-1	assessment of platelet activation using ADP
ADP 1	ADP 0.4mM	Positive control
ADP	ADP 40mM	Kontrola pozytywna

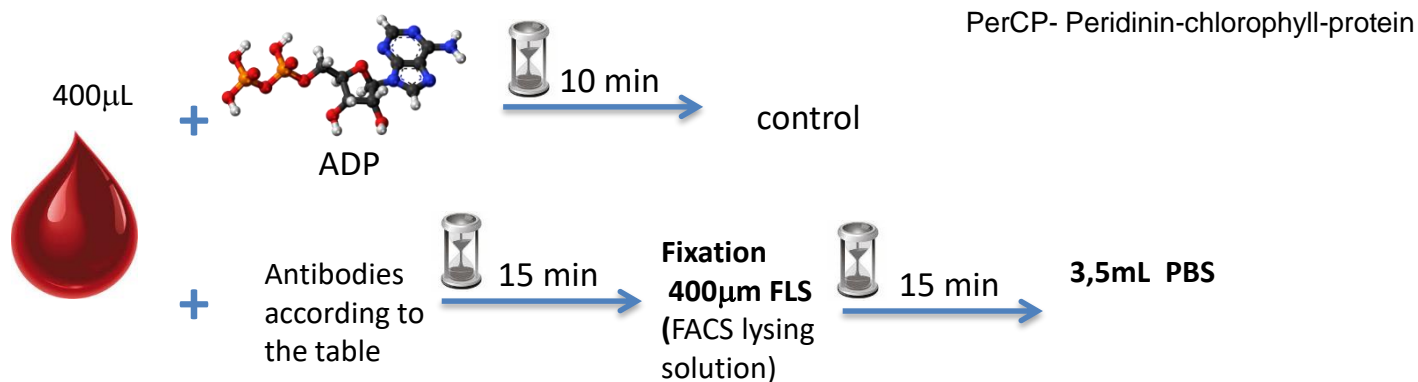

- Human blood (4 x 4.5 mL)
- ADP activation 5 min.
- Arterial flow conditio simulation.
- 130 μ L after the test.

Analysis:

- Platelet marker expression CD61
- PAC-1 glycoprotein IIb/IIIa
- CD62P for P-selectin
- Small and big PLT agregates

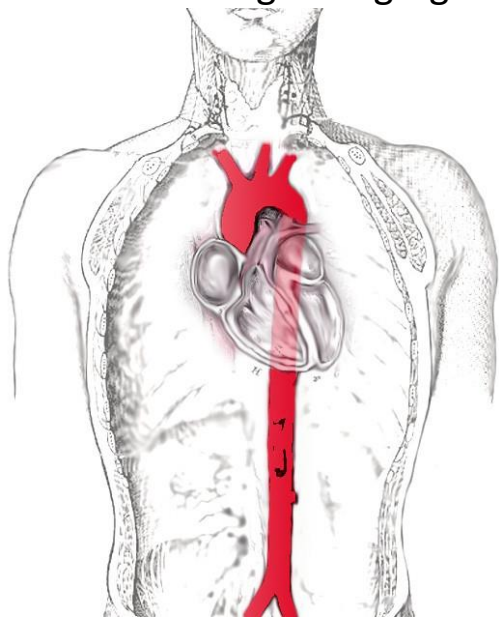

Arterial flow conditions

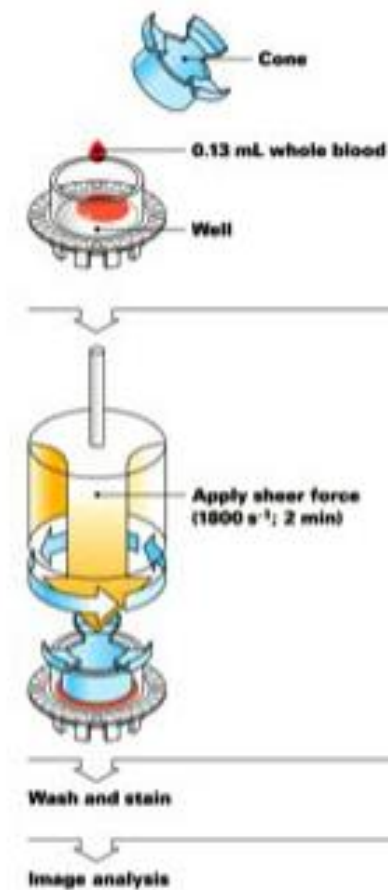
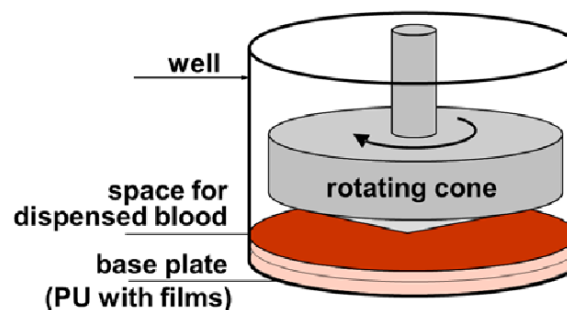

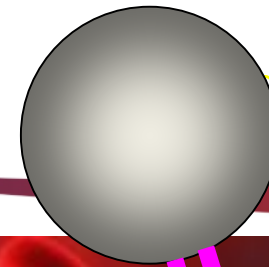

Anty- CD62

Blood cells

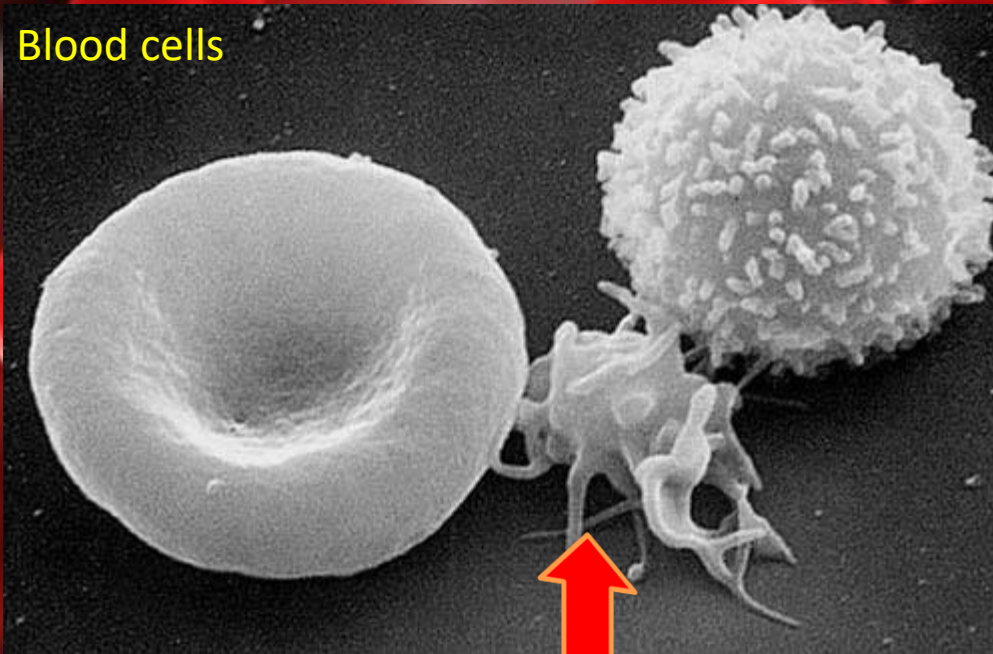

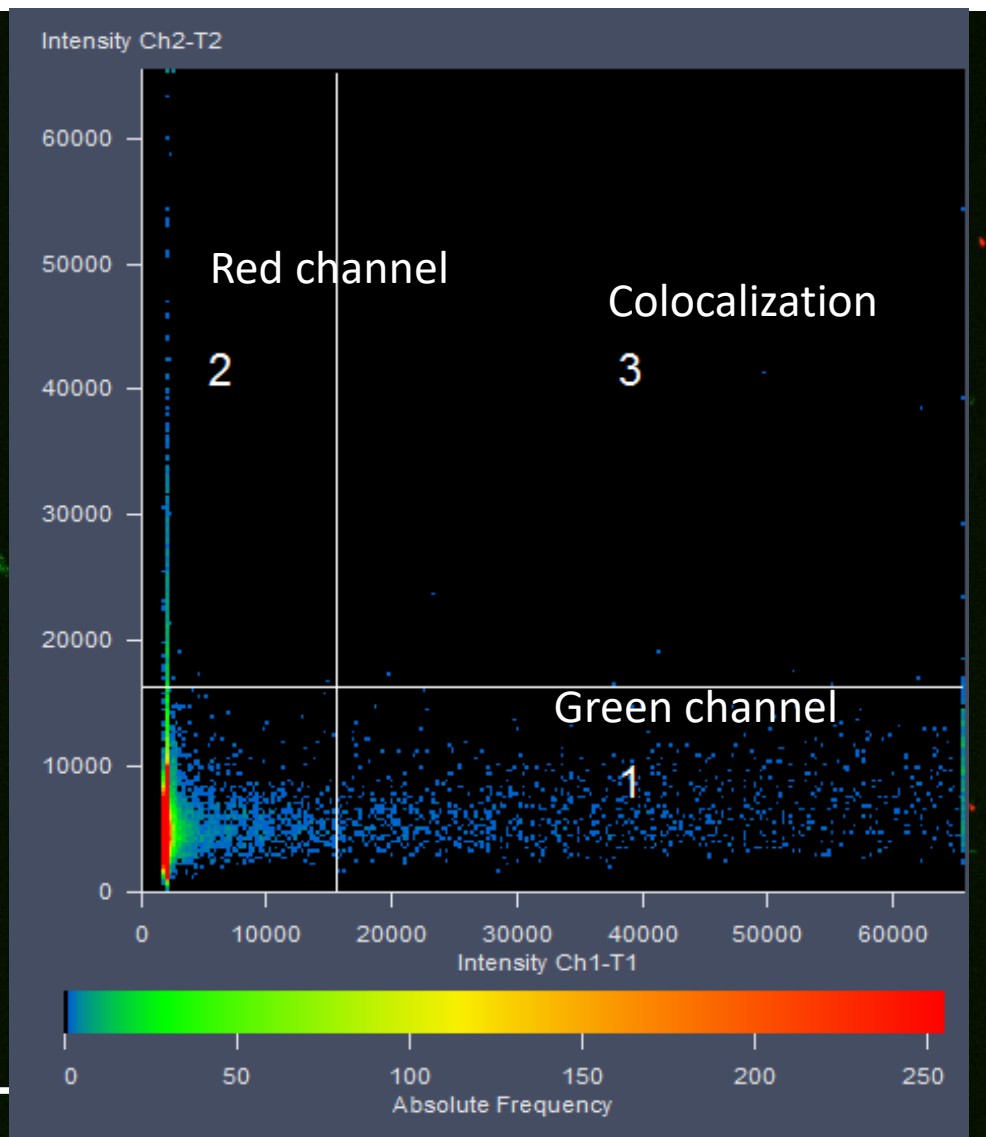

PAC-1

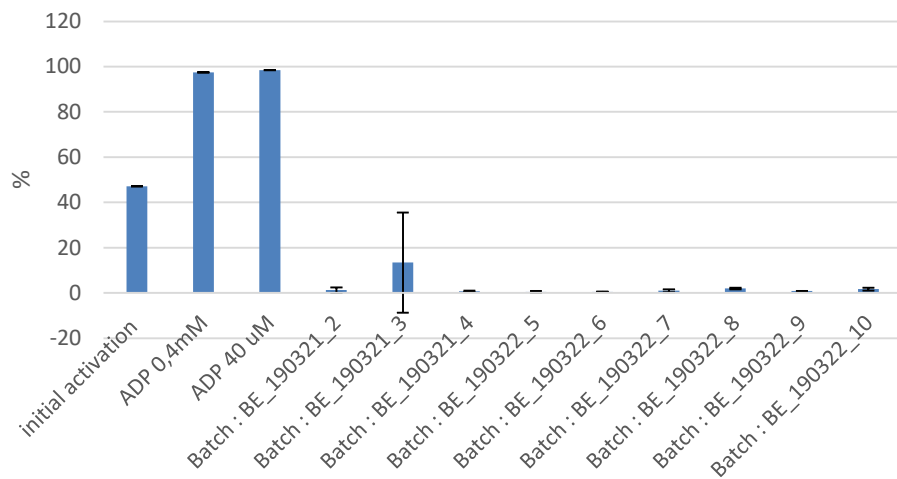

PAC-1

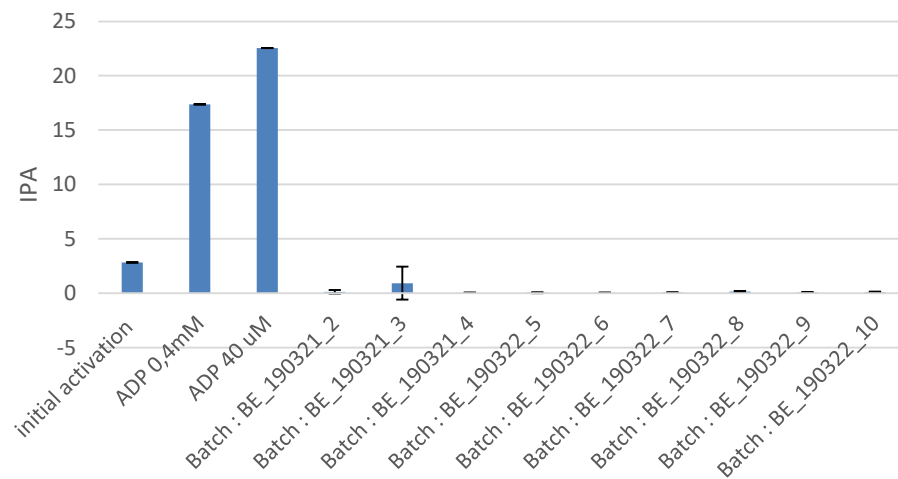

P-SEL

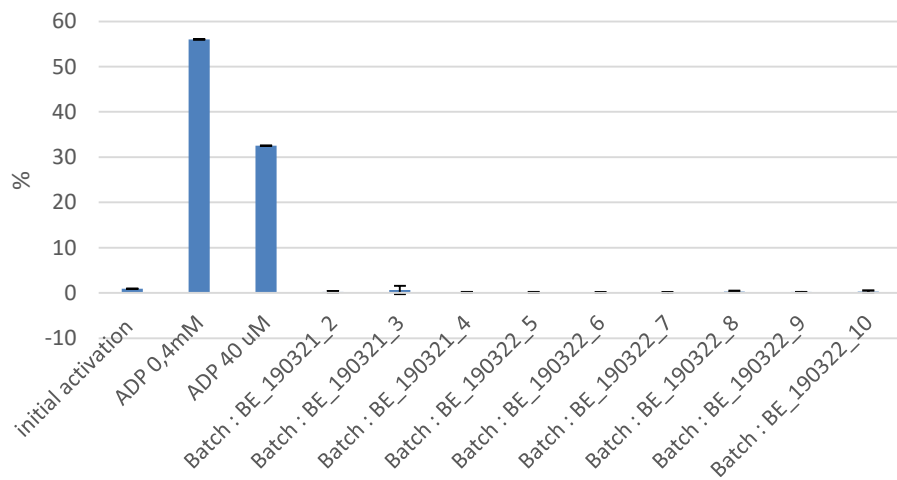

P-SEL

